



# Intel® Server System M50CYP1UR Family

## *Technical Product Specification*

An overview of product features, functions, architecture, and support specifications.

Rev. 1.0

May 2021



# M50CYP1UR

Delivering Breakthrough Data Center System Innovation – Experience What's Inside!

<This page intentionally left blank>

## ***Document Revision History***

<b>Date</b>	<b>Revision</b>	<b>Changes</b>
May 2021	1.0	Initial production release

## ***Disclaimers***

Intel technologies' features and benefits depend on system configuration and may require enabled hardware, software, or service activation. Performance varies depending on system configuration. No computer system can be absolutely secure. Check with your system manufacturer or retailer or learn more at intel.com.

You may not use or facilitate the use of this document in connection with any infringement or other legal analysis concerning Intel products described herein. You agree to grant Intel a non-exclusive, royalty-free license to any patent claim thereafter drafted which includes subject matter disclosed herein.

No license (express or implied, by estoppel or otherwise) to any intellectual property rights is granted by this document.

The products described may contain design defects or errors known as errata which may cause the product to deviate from published specifications. Current characterized errata are available on request.

Intel disclaims all express and implied warranties, including without limitation, the implied warranties of merchantability, fitness for a particular purpose, and non-infringement, as well as any warranty arising from course of performance, course of dealing, or usage in trade.

This document contains information on products, services and/or processes in development. All information provided here is subject to change without notice. Contact your Intel representative to obtain the latest Intel product specifications.

Copies of documents which have an order number and are referenced in this document may be obtained by calling 1-800-548-4725 or by visiting [www.intel.com/design/literature.htm](http://www.intel.com/design/literature.htm).

Intel, Xeon, SpeedStep, Intel Optane, and the Intel logo are trademarks of Intel Corporation or its subsidiaries in the U.S. and/or other countries.

\*Other names and brands may be claimed as the property of others.

© Intel Corporation



# Table of Contents

<b>1. Introduction</b>	<b>13</b>
1.1 Reference Documents and Support Collaterals	14
<b>2. Server System Family Overview</b>	<b>16</b>
2.1 Server System Feature Set	16
2.2 System Feature Identification	19
2.3 Front Drive Bay Options	20
2.4 Server Board Features	20
2.5 System Dimensional Data	25
2.5.1 Chassis Dimensions	25
2.5.2 Label Emboss Dimensions	26
2.5.3 Pull-Out Tab Label Emboss Dimensions	26
2.6 System Top Cover Usage	27
2.7 System Cable Routing Channels	29
2.8 Available Rack and Cabinet Mounting Kit Options	30
2.9 System Level Environmental Limits	30
2.10 System Packaging	31
<b>3. Processor Support</b>	<b>33</b>
3.1 Processor Heat Sink Module (PHM) Assembly and Processor Socket Assembly	33
3.2 Processor Thermal Design Power (TDP) Support	34
3.3 Processor Family Overview	35
3.3.1 Supported Technologies	36
3.4 Processor Population Rules	37
<b>4. Memory Support</b>	<b>38</b>
4.1 Memory Subsystem Architecture	38
4.2 Supported Memory	38
4.2.1 Standard DDR4 DIMM Support	39
4.2.2 Intel® Optane™ Persistent Memory 200 Series Module Support	40
4.3 Memory Population	42
4.3.1 DDR4 DIMM Population Rules	43
4.3.2 Intel® Optane™ Persistent Memory 200 Series Module Rules	44
4.3.3 Recommended Memory Configurations	46
4.4 Memory RAS Support	47
<b>5. System Power</b>	<b>51</b>
5.1 Power Supply Configurations	52
5.1.1 Single Power Supply (1+0) Power Configuration	52
5.1.2 Dual Power Supply 1+1 Power Configuration	52
5.1.3 Dual Power Supply 2+0 Power Configuration	53
5.2 Closed Loop System Throttling (CLST)	53
5.3 Smart Ride Through (SmaRT) Throttling	53

5.4	Power Supply Cold Redundancy .....	54
5.5	Power Supply Specification Overview.....	54
5.5.1	Power Supply Module Efficiency .....	54
5.5.2	AC Power Cord Specifications .....	55
5.6	AC Power Supply Features.....	55
5.6.1	Power Supply Status LED .....	55
5.6.2	Protection Circuits .....	56
<b>6.</b>	<b>Thermal Management .....</b>	<b>57</b>
6.1	Thermal Operation and Configuration Requirements.....	58
6.2	Thermal Management Overview.....	59
6.3	System Fans .....	60
6.4	Power Supply Module Fans .....	61
6.5	Fan Speed Control.....	61
6.5.1	Programmable Fan Pulse Width Modulation (PWM) Offset .....	61
6.5.2	Hot-Swappable Fans .....	62
6.5.3	Fan Redundancy Detection .....	62
6.5.4	Fan Domains.....	62
6.5.5	Nominal Fan Speed .....	62
6.5.6	Thermal and Acoustic Management .....	63
6.5.7	Thermal Sensor Input to Fan Speed Control .....	63
6.6	FRUSDR Utility.....	64
<b>7.</b>	<b>PCIe* Add-in Card Support.....</b>	<b>65</b>
7.1	PCIe* Riser Card Support.....	66
7.1.1	PCI Express Bifurcation.....	67
7.2	Riser Card Assembly .....	68
7.3	PCIe* Riser Card and Interposer Card Options .....	70
7.3.1	PCIe* Riser Card for Riser Slot #1 (iPC – CYP1URISER1STD) .....	70
7.3.2	PCIe* Riser Card for Riser Slot #2 (iPC – CYP1URISER2STD) .....	71
7.3.3	PCIe* NVMe* Riser Card for Riser Slot #2 (iPC – CYP1URISER2KIT).....	71
7.3.4	PCIe* Interposer Card (iPC – CYP1URISER2KIT) .....	72
7.4	Intel® Ethernet Network Adapter for OCP* Support.....	74
<b>8.</b>	<b>System Storage .....</b>	<b>76</b>
8.1	Front Drive Bay Support.....	76
8.1.1	Hot Swap Drives and Drive Mounting Rail Support.....	77
8.1.2	Hot Swap Backplane (HSBP) Support.....	82
8.1.3	4 x 2.5" Drive SATA/SAS/NVMe* Combo Backplane.....	84
8.1.4	12 x 2.5" Drive SATA/SAS/NVMe* Combo Backplane.....	86
8.2	NVMe* Storage Support.....	87
8.2.1	PCIe* SlimSAS* Support.....	87
8.2.2	PCIe* NVMe* Riser Card for Riser Slot #3 (iPC – CYP1URISER3RTM) .....	88
8.2.3	Intel® Volume Management Device (Intel® VMD) 2.0 for NVMe* .....	90

8.2.4	Intel® Virtual RAID on Chip (Intel® VROC) for NVMe*	91
8.2.5	NVMe* Drive Population Rules for Intel® VROC 7.5	92
8.3	Server Board SATA Support	94
8.3.1	SATA Support Through Mini-SAS HD Connectors	95
8.3.2	SATA Support Through M.2 Connectors	95
8.3.3	Staggered Disk Spin-Up	95
8.3.4	Intel® Virtual RAID on Chip (Intel® VROC) for SATA	96
8.4	SAS Storage Support	97
8.4.1	SAS Interposer Card (iPC – CYPASMODINT) Support	97
8.5	M.2 SSD Storage Support	99
<b>9.</b>	<b>Front Control Panel and I/O</b>	<b>100</b>
9.1	Control Panel Features	100
9.2	Front I/O Features	103
9.3	Rear I/O Features	103
9.3.1	Remote Management Port	103
9.3.2	Serial Port Support	104
9.3.3	USB Support	106
9.3.4	Video Support	107
<b>10.</b>	<b>Intel® Light Guided Diagnostics</b>	<b>109</b>
10.1	Server Board Light Guided Diagnostics	109
10.1.1	Post Code Diagnostic LEDs	110
10.1.2	System ID LED	110
10.1.3	System Status LED	110
10.1.4	BMC Boot/Reset Status LED Indicators	110
10.1.5	Processor Fault LEDs	111
10.1.6	Memory Fault LEDs	111
10.1.7	Fan Fault LEDs	112
10.2	Additional Light Guided Diagnostics	112
10.2.1	Power Supply Status LED	112
10.2.2	Front Panel Control LED Indicators	112
10.2.3	Drive Bay LEDs	112
10.2.4	Drive Activity LED for Front Control Panel	112
<b>Appendix A.</b>	<b>Getting Help</b>	<b>113</b>
<b>Appendix B.</b>	<b>Integration and Usage Tips</b>	<b>114</b>
<b>Appendix C.</b>	<b>Post Code Diagnostic LED Decoder</b>	<b>115</b>
C.1	Early POST Memory Initialization MRC Diagnostic Codes	116
C.2	BIOS POST Progress Codes	118
<b>Appendix D.</b>	<b>Post Error Codes</b>	<b>121</b>
D.1	POST Error Beep Codes	127
D.2	Processor Initialization Error Summary	128
<b>Appendix E.</b>	<b>System Configuration Table for Thermal Compatibility</b>	<b>130</b>

E.1	Normal Operating Mode .....	130
E.2	Fan Fail Mode.....	135
<b>Appendix F.</b>	<b>System Sensors.....</b>	<b>138</b>
<b>Appendix G.</b>	<b>Statement of Volatility.....</b>	<b>142</b>
<b>Appendix H.</b>	<b>Product Regulatory Compliance.....</b>	<b>144</b>
<b>Appendix I.</b>	<b>Glossary .....</b>	<b>149</b>

## List of Figures

Figure 1.	Intel® Server System M50CYP1UR.....	13
Figure 2.	Server System Components Overview.....	19
Figure 3.	Back Panel Feature Identification.....	19
Figure 4.	Front Control Panel Feature Identification.....	20
Figure 5.	4 x 2.5" Front Drive Bay Configuration – M50CYP1UR204.....	20
Figure 6.	12 x 2.5" Front Drive Bay Configuration – M50CYP1UR212 .....	20
Figure 7.	Intel® Server Board M50CYP2SB1U Architectural Block Diagram .....	21
Figure 8.	Intel® Server Board M50CYP2SB1U Component / Feature Identification .....	22
Figure 9.	Intel® Light-Guided Diagnostics – LED Identification .....	23
Figure 10.	Intel® Light-Guided Diagnostics – DIMM Fault LEDs.....	24
Figure 11.	System Configuration and Recovery Jumpers.....	24
Figure 12.	Chassis Dimensions.....	25
Figure 13.	Label Emboss Dimensions.....	26
Figure 14.	Pull-out Tab Location .....	26
Figure 15.	Pull-out Fab Label Emboss Dimensions .....	27
Figure 16.	System Top Cover Shipping Screws.....	27
Figure 17.	System Top Cover Removal.....	28
Figure 18.	System Top Cover Installation.....	28
Figure 19.	System Cable Routing Channels .....	29
Figure 20.	Supported Processor Heat Sinks.....	33
Figure 21.	PHM Components and Processor Socket Reference Diagram.....	34
Figure 22.	3 <sup>rd</sup> Gen Intel® Xeon® Scalable Processor Identification.....	35
Figure 23.	Memory Slot Connectivity .....	38
Figure 24.	Standard SDRAM DDR4 DIMM Module .....	39
Figure 25.	Intel® Optane™ Persistent Memory 200 series Module .....	40
Figure 26.	<F2> BIOS Setup Screen Navigation for Intel® Optane™ PMem Setup Options .....	41
Figure 27.	Intel® Optane™ PMem Configuration Menu in <F2> BIOS Setup.....	42
Figure 28.	Intel® Server System M50CYP1UR Family Memory Slot Layout .....	42
Figure 29.	Memory Slot Identification.....	46
Figure 30.	Power Supply Module Identification .....	51
Figure 31.	Power Supply Module Partially Out of Chassis.....	51

Figure 32. Power Supply Module .....	52
Figure 33. AC Power Cable Connector .....	55
Figure 34. AC Power Cord Specification.....	55
Figure 35. System Airflow and Fan Identification.....	57
Figure 36. System DIMM/DIMM Blanks Configuration .....	59
Figure 37. System Fan Assembly.....	61
Figure 38. High Level Fan Speed Control Structure .....	64
Figure 39. Server System PCIe* Riser Add-in Card Areas .....	65
Figure 40. Server System Back Bay Add-in Card Areas.....	65
Figure 41. PCIe* add-in Card Orientation .....	67
Figure 42. Riser Bracket Components.....	68
Figure 43. Add-in Card Placement into Server System Chassis.....	69
Figure 44. Bracket for Riser Card on Riser Slot #1– Two Views.....	69
Figure 45. Bracket for Riser Card on Riser Slot #2– Two Views.....	69
Figure 46. Bracket for Riser Card on Riser Slot #3– Two Views (NVMe* Support Only).....	70
Figure 47. Bracket for PCIe* Interposer Riser Card – Two Views .....	70
Figure 48. PCIe* Riser Card for Riser Slot #1 .....	70
Figure 49. PCIe* Riser Card for Riser Slot #2 .....	71
Figure 50. PCIe* NVMe* Riser Card for Riser Slot #2.....	71
Figure 51. PCIe* Interposer Riser Card.....	72
Figure 52. PCIe* Interposer Riser Card to PCIe* NVMe* Riser Card Connectivity.....	73
Figure 53. Intel® Ethernet Network Adapter for OCP* Placement.....	74
Figure 54. OCP* Adapter Bay Filler Removal.....	75
Figure 55. OCP* Adapter with Pull Tab Installation.....	75
Figure 56. 4 x 2.5" Front Drive Bay Configuration – M50CYP1UR204.....	76
Figure 57. 12 x 2.5" Front Drive Bay Configuration – M50CYP1UR212 .....	76
Figure 58. 2.5" Drive Bay Components .....	77
Figure 59. 2.5" Hot-Swap Drive Blank Top / Bottom and Attaching the Two.....	77
Figure 60. 2.5" 7 mm Height Drive Assembly with Drive Blank .....	78
Figure 61. 2.5" 7 mm Drive Outside Chassis, Ready for Installation.....	78
Figure 62. 7 mm Drive Installation into 2.5" Drive Bay.....	79
Figure 63. 7 mm Drive Removal from 2.5" Drive Bay .....	79
Figure 64. 15 mm Drive Insertion into 2.5" Drive Bay, Ready to Install.....	80
Figure 65. 15 mm Drive Insertion into 2.5" Drive Bay.....	80
Figure 66. 15 mm Drive Removal from 2.5" Drive Bay .....	80
Figure 67. Drive Bay LED Identification.....	81
Figure 68. 4 x 2.5" Hot Swap Backplane Placement.....	82
Figure 69. 12 x 2.5" Hot Swap Backplane Placement .....	82
Figure 70. Server Board HSBP Power Connector .....	84
Figure 71. 4 x 2.5" SAS/SATA/NVMe* Hot Swap Backplane – Front Side .....	84
Figure 72. 4 x 2.5" SAS/SATA/NVMe* Hot Swap Backplane – Back Side .....	85

Figure 73. 12 x 2.5" SAS/SATA/NVMe* Hot Swap Backplane – Front Side .....	86
Figure 74. 12 x 2.5" SAS/SATA/NVMe* Hot Swap Backplane – Back Side.....	86
Figure 75. PCIe* SlimSAS* Connectors .....	88
Figure 76. PCIe* NVMe* SlimSAS* Riser Card for Riser Slot #3 .....	88
Figure 77. Cable Routing Between PCIe* NVMe* Riser Card and HSBP .....	89
Figure 78. NVMe* Storage Bus Event / Error Handling.....	90
Figure 79. Intel® VROC 7.5 Key Insertion.....	92
Figure 80. 4 x 2.5" SAS/SATA/NVMe* Hot Swap Backplane – Front side.....	93
Figure 81. 4 x 2.5" SAS/SATA/NVMe* Hot Swap Backplane – Back Side .....	93
Figure 82. 12 x 2.5" SAS/SATA/NVMe* Hot Swap Backplane – Front Side .....	93
Figure 83. 12 x 2.5" SAS/SATA/NVMe* Hot Swap Backplane – Back Side.....	94
Figure 84. SATA Ports on Server Board.....	95
Figure 85. BIOS Setup Mass storage Controller Configuration Screen .....	96
Figure 86. SAS Interposer Card.....	98
Figure 87. SAS Interposer Card Placement.....	98
Figure 88. Intel® SAS RAID Module Placement.....	99
Figure 89. M.2 Module Connector Location.....	99
Figure 90. Front Control Panel Features .....	100
Figure 91. Front I/O Features .....	103
Figure 92. Rear I/O Features .....	103
Figure 93. Remote Management Port.....	103
Figure 94. Serial Port A .....	104
Figure 95. RJ45 Serial Port A Pin Orientation .....	104
Figure 96. J4A2 Jumper Header for Serial Port A Pin 7 Configuration .....	105
Figure 97. Serial Port B Header (internal) .....	105
Figure 98. External USB 3.0 Connector Ports.....	106
Figure 99. Internal USB 2.0 Type-A Connector .....	107
Figure 100. Intel® Server System M50CYP1UR Family Onboard LEDs .....	109
Figure 101. Exploded View of POST Code Diagnostic, System ID, and System Status LEDs .....	110
Figure 102. Memory Fault LED Location .....	112
Figure 103. System Fan Fault LEDs .....	112
Figure 104. Server Board POST Diagnostic LEDs .....	115
Figure 105. System Sensor Map .....	138

## List of Tables

Table 1. Intel® Server M50CYP Family Reference Documents and Support Collaterals .....	14
Table 2. Intel® Server System M50CYP1UR Family Features .....	16
Table 3. System Environmental Limits Summary.....	30
Table 4. 3 <sup>rd</sup> Gen Intel® Xeon® Scalable Processor Family Feature Comparison .....	36
Table 5. Supported DDR4 DIMM Memory .....	39

Table 6. Maximum Supported Standard DDR4 DIMM Speeds by Processor Shelf.....	40
Table 7. DDR4 DIMM Attributes Table for “Identical” and “Like” DIMMs .....	43
Table 8. Intel® Optane™ Persistent Memory 200 Series Module Support.....	45
Table 9. Standard DDR4 DIMMs Compatible with Intel® Optane™ Persistent Memory 200 Series Module .....	45
Table 10. Standard DDR4 DIMM-only per socket population configurations.....	46
Table 11. Standard DDR4 DIMM and Intel® Optane™ Persistent Memory 200 Series Module (PMem) Population Configurations.....	47
Table 12. Memory RAS Features .....	47
Table 13. Intel® Optane™ Persistent Memory 200 Series RAS Features .....	49
Table 14. Compatibility of RAS features Intel® SGX, Intel® TME, and Intel® TME-MT .....	50
Table 15. 1300 W and 1600 W AC Power Supply Option Efficiency (80 PLUS* Titanium) .....	54
Table 16. AC power Cord Specifications .....	55
Table 17. LED Indicators .....	55
Table 18. Over Current Protection, 1300 W and 1600 W Power Supply.....	56
Table 19. Over Voltage Protection (OVP) Limits, 1300 W and 1600 W Power Supply .....	56
Table 20. System Volumetric Airflow – M50CYP1UR204.....	57
Table 21. System Volumetric Airflow – M50CYP1UR212 .....	57
Table 22. PCIe* add-in Card Airflow (LFM) Support Limits – M50CYP1UR204, M50CYP1UR212 Fan Normal	58
Table 23. PCIe* add-in Card Airflow (LFM) Support Limits – M50CYP1UR204, M50CYP1UR212 Fan Failure .	59
Table 24. Processor / Chipset PCIe* Port Routing .....	66
Table 25. PCIe* Riser Card Connector Description .....	70
Table 26. PCIe* Riser Card Connector Description .....	71
Table 27. PCIe* NVMe* Riser Card Connector Description.....	71
Table 28. PCIe* Interposer Riser Card Connector Description .....	72
Table 29. PCIe* Interposer Riser Slot Pinout.....	73
Table 30. Supported Intel® Ethernet Network Adapters for OCP* .....	74
Table 31. Drive Status LED States.....	81
Table 32. Drive Activity LED States.....	81
Table 33. I <sup>2</sup> C Cable Connector Pinout.....	85
Table 34. Power Connector Pinout.....	85
Table 35. I <sup>2</sup> C Cable Connector Pinout.....	86
Table 36. Power Connector Pinout.....	87
Table 37. CPU to PCIe* NVMe* SlimSAS* Connector Routing .....	88
Table 38. PCIe*NVMe* SlimSAS* Riser Card Connector Description .....	89
Table 39. CPU to PCIe* NVMe* SlimSAS* Connector Routing .....	91
Table 40. Optional VROC Upgrade Key - Supported NVMe* RAID Features .....	92
Table 41. SATA and sSATA Controller Feature Support.....	94
Table 42. Power / Sleep LED Functional States .....	100
Table 43. System Status LED State Definitions.....	101
Table 44. RJ45 Serial Port A Connector Pinout .....	104
Table 45. Serial Port B Header Pinout.....	106
Table 46. Internal USB 2.0 Type-A Connector Pinout.....	107

Table 47. Supported Video Resolutions .....	107
Table 48. BMC Boot / Reset Status LED Indicators.....	111
Table 49. POST Progress Code LED Example.....	116
Table 50. MRC Progress Codes .....	116
Table 51. MRC Fatal Error Codes.....	117
Table 52. POST Progress Codes.....	118
Table 53. POST Error Messages and Handling.....	122
Table 54. POST Error Beep Codes.....	127
Table 55. Integrated BMC Beep Codes .....	127
Table 56. Mixed Processor Configurations Error Summary.....	128
Table 57. Thermal Configuration Matrix – Normal Operating Mode (R1204CYP and R1212CYP) .....	132
Table 58. Thermal Configuration Matrix – Fan Fail Mode (R1204CYP and R1212CYP).....	135
Table 59. System Sensors .....	139
Table 60. Server Board Components .....	143
Table 61. System Board Components.....	143
Table 62. Server Chassis Components .....	143



## 1. Introduction

---

This technical product specification (TPS) provides a high-level overview of the features, functions, architecture, and support specifications of the Intel® Server System M50CYP1UR family.

The Intel® Server System M50CYP1UR family is a purpose built system that delivers power and performance at a peak efficiency in a 1U rack mount server form factor. It features the 3<sup>rd</sup> Gen Intel® Xeon® Scalable processor family in a dual socket configuration, delivering high core count and new hardware-enhanced security features. Previous generation Intel® Xeon® processor and Intel® Xeon® Scalable processor families are not supported.

The system provides high memory bandwidth and capacity of up to 32 DDR4 DIMMs for memory intensive workloads. The product family also supports Intel® Optane™ persistent memory 200 series modules.

The system has high memory capacity, high-speed networking, storage up to 12 SAS/SATA/NVMe\* front bay drives, and I/O flexibility. These capabilities are combined with an innovative design to provide a reliable server system for business IT, appliance, data center, cloud and high-performance computing applications.

For a complete overview of system features and functions, both this system TPS and the *Intel® Server Board M50CYP2SB Family Technical Product Specification (TPS)* should be referenced.

---

**Note:** This document includes several references to Intel websites where additional product information can be downloaded. However, these public Intel sites do not include content for products in development. Content for these products will be available on the public Intel websites after their public launch.

**Note:** In this document, the 3<sup>rd</sup> Gen Intel® Xeon® Scalable processor family may be referred to simply as “processor”.

**Note:** For additional technical information, see the documents in Section 1.1. Some of the documents listed in the appendix are classified as “Intel Confidential”. These documents are made available under a Non-Disclosure Agreement (NDA) with Intel and must be ordered through your local Intel representative.

---

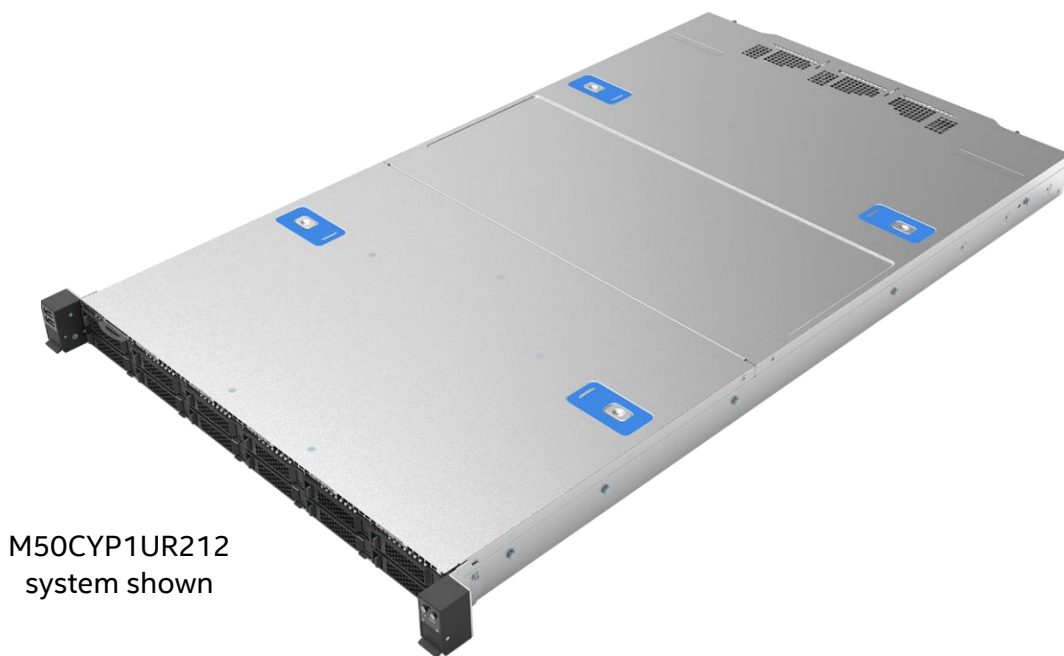

M50CYP1UR212  
system shown

**Figure 1. Intel® Server System M50CYP1UR**

## 1.1 Reference Documents and Support Collaterals

For additional information, see the product support collaterals specified in the following table. The following webpage provides support information for the M50CYP family:

<https://www.intel.com/content/www/us/en/support/products/200321.html>

**Table 1. Intel® Server M50CYP Family Reference Documents and Support Collaterals**

Topic	Document Title or Support Collateral	Document Classification
For system integration instructions and service guidance	<i>Intel® Server System M50CYP2UR Family System Integration and Service Guide</i>	Public
For system integration instructions and service guidance	<i>Intel® Server System M50CYP1UR Family System Integration and Service Guide</i>	Public
For technical system-level description	<i>Intel® Server System M50CYP2UR Family Technical Product Specification</i>	Public
For technical system-level description	<i>Intel® Server System M50CYP1UR Family Technical Product Specification</i>	Public
For technical board-level description	<i>Intel® Server Board M50CYP2SB Family Technical Product Specification</i>	Public
For server configuration guidance and compatibility	<i>Intel® Server M50CYP Family Configuration Guide</i>	Public
For information on the Integrated BMC Web Console	<i>Intel® Integrated Baseboard Management Controller Web Console (Integrated BMC Web Console) User Guide For the Intel® Server Board D50TNP and M50CYP Families</i>	Public
For BIOS technical information on Intel® Server M50CYP Family	<i>BIOS Firmware External Product Specification (EPS) For the Intel® Server Board D50TNP and M50CYP Families</i>	Intel Confidential
For BIOS setup information on Intel® Server M50CYP Family	<i>BIOS Setup Utility User Guide For the Intel® Server Board D50TNP and M50CYP Families</i>	Public
For BMC technical information on Intel® Server M50CYP Family	<i>Integrated Baseboard Management Controller Firmware External Product Specification For the Intel® Server System D50TNP and M50CYP Families</i>	Intel Confidential
Base specifications for the IPMI architecture and interfaces	<i>Intelligent Platform Management Interface Specification Second Generation v2.0</i>	Intel Confidential
Specifications for the PCIe* 3.0 architecture and interfaces	<i>PCIe* Base Specification, Revision 3.0</i> <a href="http://www.pcisig.com/specifications">http://www.pcisig.com/specifications</a>	Public
Specifications for the PCIe* 4.0 architecture and interfaces	<i>PCIe* Base Specification, Revision 4.0</i> <a href="http://www.pcisig.com/specifications">http://www.pcisig.com/specifications</a>	Public
Specification for OCP*	Open Compute Project* (OCP*) Specification	Intel Confidential
TPM for PC Client specifications	<i>TPM PC Client Specifications, Revision 2.0</i>	Intel Confidential
Functional specifications of 3 <sup>rd</sup> Gen Intel® Xeon® Scalable processor family	<i>3rd Generation Intel® Xeon® Scalable Processors, Codename Ice Lake-SP External Design Specification (EDS): Document IDs: 574451, 574942, 575291</i>	Intel Confidential
BIOS and BMC Security Best Practices	<i>Intel® Server Systems Baseboard Management Controller (BMC) and BIOS Security Best Practices White Paper</i> <a href="https://www.intel.com/content/www/us/en/support/articles/000055785/server-products.html">https://www.intel.com/content/www/us/en/support/articles/000055785/server-products.html</a>	Public
Managing an Intel Server Overview	<i>Managing an Intel Server System 2020</i> <a href="https://www.intel.com/content/www/us/en/support/articles/000057741/server-products.html">https://www.intel.com/content/www/us/en/support/articles/000057741/server-products.html</a>	Public

Topic	Document Title or Support Collateral	Document Classification
For technical information on Intel® Optane™ persistent memory 200	<i>Intel® Optane™ Persistent Memory 200 Series Operations Guide</i>	Intel Confidential
For setup information for Intel® Optane™ persistent memory 200	<i>Intel® Optane™ Persistent Memory Startup Guide</i>	Public
For latest system software updates: BIOS and Firmware	<i>Intel® System Update Package (SUP) for Intel® Server M50CYP Family</i>	Public
	<i>Intel® System Firmware Update Utility (SYSPWUPDT) - Various operating system support</i>	
	<i>Intel® System Firmware Update Utility User Guide</i>	
To obtain full system information	<i>Intel® SYSINFO Utility for Intel® Server M50CYP Family</i>	Public
	<i>Intel® System Information Utility User Guide</i>	
To configure, save, and restore various system options	<i>Intel® SYSCFG Utility for Intel® Server M50CYP Family – Various operating system support</i>	Public
	<i>Intel® System Configuration Utility User Guide</i>	
Product Warranty Information	<i>Warranty Terms and Conditions</i> <a href="https://www.intel.com/content/www/us/en/support/services/000005886.html">https://www.intel.com/content/www/us/en/support/services/000005886.html</a>	Public

---

**Note:** Intel Confidential documents are made available under a Non-Disclosure Agreement (NDA) with Intel and must be ordered through your local Intel representative.

---

## 2. Server System Family Overview

This chapter provides an overview of the system and chassis features and dimensions, as well as environmental and packaging specifications.

### 2.1 Server System Feature Set

The following table provides a high-level overview of the server system features and available options supported by the Intel® Server System M50CYP1UR family.

**Table 2. Intel® Server System M50CYP1UR Family Features**

Feature	Details
<b>Chassis Type</b>	1U rack mount chassis
<b>Server Board</b>	Intel® Server Board M50CYP2SB1U
<b>Processor Support</b>	<ul style="list-style-type: none"> <li>Dual Socket-P4 LGA4189</li> <li>Supported 3<sup>rd</sup> Gen Intel® Xeon® Scalable processor family SKUs:               <ul style="list-style-type: none"> <li>Intel® Xeon® Platinum 8300 processor</li> <li>Intel® Xeon® Gold 6300 processor</li> <li>Intel® Xeon® Gold 5300 processor</li> <li>Intel® Xeon® Silver 4300 processor</li> </ul> </li> <li><b>Note:</b> Supported 3<sup>rd</sup> Gen Intel® Xeon® Scalable processor SKUs must Not end in (H), (L), (U), or (Q). All other processor SKUs are supported.</li> <li>UPI links: up to three at 11.2 GT/s (Platinum and Gold families) or up to two at 10.4 GT/s (Silver family)</li> <li><b>Note:</b> Previous generation Intel® Xeon® processor and Intel® Xeon® Scalable processor families are not supported.</li> </ul>
<b>Maximum Supported Processor Thermal Design Power (TDP)</b>	<ul style="list-style-type: none"> <li>3<sup>rd</sup> Gen Intel® Xeon® Scalable processors up to 270 W.</li> <li><b>Note:</b> The maximum supported processor TDP depends on system configuration. For more information, see <a href="#">Appendix E</a> for Thermal Compatibility.</li> </ul>
<b>Chipset</b>	<ul style="list-style-type: none"> <li>Intel® C621A Chipset (PCH)</li> </ul>
<b>Memory Support</b>	<ul style="list-style-type: none"> <li>32 DIMM slots               <ul style="list-style-type: none"> <li>16 DIMM slots per processor, eight memory channels per processor</li> <li>Two DIMMs per channel</li> </ul> </li> <li>All DDR4 DIMMs must support ECC</li> <li>Registered DDR4 (RDIMM), 3DS-RDIMM, Load Reduced DDR4 (LRDIMM), 3DS-LRDIMM               <ul style="list-style-type: none"> <li><b>Note:</b> 3DS = 3 Dimensional Stacking</li> </ul> </li> <li>Intel® Optane™ persistent memory 200 series</li> <li>Memory capacity               <ul style="list-style-type: none"> <li>Up to 6 TB per processor (processor SKU dependent)</li> </ul> </li> <li>Memory data transfer rates               <ul style="list-style-type: none"> <li>Up to 3200 MT/s at one or two DIMMs per channel (processor SKU dependent)</li> </ul> </li> <li>DDR4 standard voltage of 1.2V</li> </ul>
<b>System Fans</b>	<ul style="list-style-type: none"> <li>Eight managed 40 mm hot swap capable system fans</li> <li>Integrated fans included with each installed power supply module</li> <li><b>Note:</b> System fan redundancy is supported on specific system configurations. For details, see <a href="#">Chapter 6</a>.</li> </ul>
<b>Power Supply Options</b>	<p>The server system can have up to two power supply modules installed, supporting the following power configurations: 1+0, 1+1 redundant power, and 2+0 combined power.</p> <p>Three power supply options:</p> <ul style="list-style-type: none"> <li>AC 1300 W Titanium</li> <li>AC 1600 W Titanium</li> </ul>
<b>Server Board Network Support</b>	See optional Open Compute Project (OCP*) adapter support below.

Feature	Details
<b>Open Compute Project* (OCP*) Adapter Support</b>	<p>Onboard x16 PCIe* 4.0 OCP 3.0 Mezzanine connector (Small Form-Factor) supports the following Intel accessory options:</p> <ul style="list-style-type: none"> <li>• Dual port, RJ45, 10/1 GbE, - iPC- X710T2LOCPV3</li> <li>• Quad port, SFP+ DA, 4x 10 GbE - iPC- X710DA4OCPV3</li> <li>• Dual Port, QSFP28 100/50/25/10 GbE - iPC- E810CQDA2OCPV3</li> <li>• Dual Port, SFP28 25/10 GbE - iPC-E810XXVDA2OCPV3</li> </ul>
<b>Riser Card Support</b>	<p>Concurrent support for up to four riser cards, including one PCIe Interposer riser card with support for up to three PCIe* add-in cards. In the below description HL = Half Length, LP = Low Profile.</p> <p><b>Riser Slot #1:</b></p> <ul style="list-style-type: none"> <li>• Riser Slot #1 supports x16 PCIe* lanes routed from CPU 0</li> <li>• PCIe* 4.0 support for up to 32 GB/s</li> </ul> <p><b>Riser Slot #1 supports the following Intel Riser Card option:</b></p> <ul style="list-style-type: none"> <li>• One PCIe* slot Riser card supporting (one) – LP/HL, single-width slot (x16 electrical, x16 mechanical) iPC – CYP1URISER1STD</li> </ul> <p><b>Riser Slot #2:</b></p> <ul style="list-style-type: none"> <li>• Riser Slot #2 supports X24 PCIe* lanes routed from CPU 1</li> <li>• PCIe* 4.0 support for up to 32 GB/s</li> </ul> <p><b>Riser Slot #2 supports the following Intel Riser Card options:</b></p> <ul style="list-style-type: none"> <li>• One PCIe* slot Riser card supporting (one) – LP/HL, single-width slot (x16 electrical, x16 mechanical) iPC – CYP1URISER2STD</li> <li>• NVMe* Riser card supporting (one) – LP/HL, single-width slot (x16 electrical, x16 mechanical) + (one) – x8 PCIe* NVMe* SlimSAS* connector with re-timer. Included in iPC – CYP1URISER2KIT</li> </ul> <p><b>PCIe* Interposer Riser Slot (requires PCIe* NVMe* riser card in Riser Slot #2)</b></p> <ul style="list-style-type: none"> <li>• PCIe* Interposer Riser Slot supports the PCIe* interposer riser card as an accessory option. This card supports one PCIe* add-in card (x8 electrical, x8 mechanical). The PCIe* interposer riser card can be used only when it is connected to the PCIe* NVMe* riser card in Riser Slot #2. The interposer card uses x8 PCIe* data lanes routed from the PCIe* SlimSAS* connector on the PCIe* NVMe* riser card. The Intel accessory kit includes the PCIe* interposer riser card, PCIe* NVMe* riser card, and PCIe* interposer cable. iPC – CYP1URISER2KIT</li> </ul> <p><b>Riser Slot #3:</b></p> <ul style="list-style-type: none"> <li>• Riser Slot #3 supports x16 PCIe* lanes routed from CPU 1</li> <li>• PCIe* 4.0 support for up to 32 GB/s</li> </ul> <p><b>Riser Slot #3 supports the following Intel Riser Card option:</b></p> <ul style="list-style-type: none"> <li>• NVMe* riser card supporting (two) – PCIe* NVMe* SlimSAS* connectors iPC – CYPRISER3RTM</li> </ul> <p><b>Note:</b> Riser Slot #3 does not support add-In cards</p>
<b>PCIe* NVMe* Support</b>	<ul style="list-style-type: none"> <li>• Support for up to 10 PCIe* NVMe* Interconnects <ul style="list-style-type: none"> <li>○ Eight server board SlimSAS* connectors, four per processor</li> <li>○ Two M.2 NVMe/SATA connectors</li> </ul> </li> <li>• Additional NVMe* support through select Riser Card options (See Riser Card Support)</li> <li>• Intel® Volume Management Device 2.0 (Intel® VMD 2.0) support</li> <li>• Intel® Virtual RAID on CPU 7.5 (Intel® VROC 7.5) support using one of the three types of VROC keys (available as an Intel accessory option)</li> </ul>
<b>Video Support</b>	<ul style="list-style-type: none"> <li>• Integrated 2D video controller</li> <li>• 128 MB of DDR4 video memory</li> <li>• One VGA DB-15 external connector in the back</li> </ul>
<b>Server Board SATA Support</b>	<ul style="list-style-type: none"> <li>• 10 x SATA III ports (6 Gb/s, 3 Gb/s and 1.5 Gb/s transfer rates supported) <ul style="list-style-type: none"> <li>○ Two M.2 connectors – SATA / PCIe*</li> <li>○ Two 4-port Mini-SAS HD (SFF-8643) connectors</li> </ul> </li> </ul>

Feature	Details
<b>USB Support</b>	<ul style="list-style-type: none"> <li>• Three USB 3.0 connectors on the back panel</li> <li>• One USB 3.0 and one USB 2.0 connector on the front panel</li> <li>• One USB 2.0 internal Type-A connector</li> </ul>
<b>Serial Support</b>	<ul style="list-style-type: none"> <li>• One external RJ-45 Serial Port A connector on the back panel</li> <li>• One internal DH-10 Serial Port B header for optional front or rear serial port support. The port follows the DTK pinout specifications.</li> </ul>
<b>Front Drive Bay Options</b>	<ul style="list-style-type: none"> <li>• 4 x 2.5" SAS/SATA/NVMe* hot swap drive bays</li> <li>• 12 x 2.5" SAS/SATA/NVMe* hot swap drive bays</li> </ul>
<b>Server Management</b>	<ul style="list-style-type: none"> <li>• Integrated Baseboard Management Controller (BMC)</li> <li>• Intelligent Platform Management Interface (IPMI) 2.0 compliant</li> <li>• Redfish* compliant</li> <li>• Support for Intel® Data Center Manager (DCM)</li> <li>• Support for Intel® Server Debug and Provisioning Tool (SDPTool)</li> <li>• Dedicated server board RJ45 1 GbE management port</li> <li>• Light Guided Diagnostics</li> </ul>
<b>System Configuration and Recovery Jumpers</b>	<ul style="list-style-type: none"> <li>• BIOS load defaults</li> <li>• BIOS Password clear</li> <li>• Intel® Management Engine firmware force update Jumper</li> <li>• BMC force update</li> <li>• BIOS_SVN Downgrade</li> <li>• BMC_SVN Downgrade</li> </ul> <p>For more information, see the <i>Intel® Server Board M50CYP2SB Family Technical Product Specification (TPS)</i>.</p>
<b>Security Support</b>	<ul style="list-style-type: none"> <li>• Intel® Platform Firmware Resilience (Intel® PFR) technology with an I<sup>2</sup>C interface</li> <li>• Intel® Software Guard Extensions (Intel® SGX)</li> <li>• Intel® CBnT – Converged Intel® Boot Guard and Trusted Execution Technology (Intel® TXT)</li> <li>• Intel® Total Memory Encryption (Intel® TME)</li> <li>• Trusted platform module 2.0 (Rest of World) – iPC J33567-151 (accessory option)</li> <li>• Trusted platform module 2.0 (China Version) – iPC J12350-150 (accessory option)</li> </ul>
<b>Supported Rack Mount Kit Accessory Options</b>	<ul style="list-style-type: none"> <li>• <b>CYPHALFEXTRAIL</b> –Value Rack Mount Rail Kit</li> <li>• <b>CYPFULLEXTRAIL</b> – Premium Rail Kit with cable management arm (CMA) support</li> <li>• <b>AXXCMA2</b> – Cable Management Arm (supports <b>CYPFULLEXTRAIL</b> only)</li> </ul> <p>See <a href="#">Section 2.8</a></p>
<b>BIOS</b>	Unified Extensible Firmware Interface (UEFI)-based BIOS (legacy boot not supported)



## 2.2 System Feature Identification

This section provides system views and identifies key system features for all supported system configurations of the Intel® Server System M50CYP1UR family.

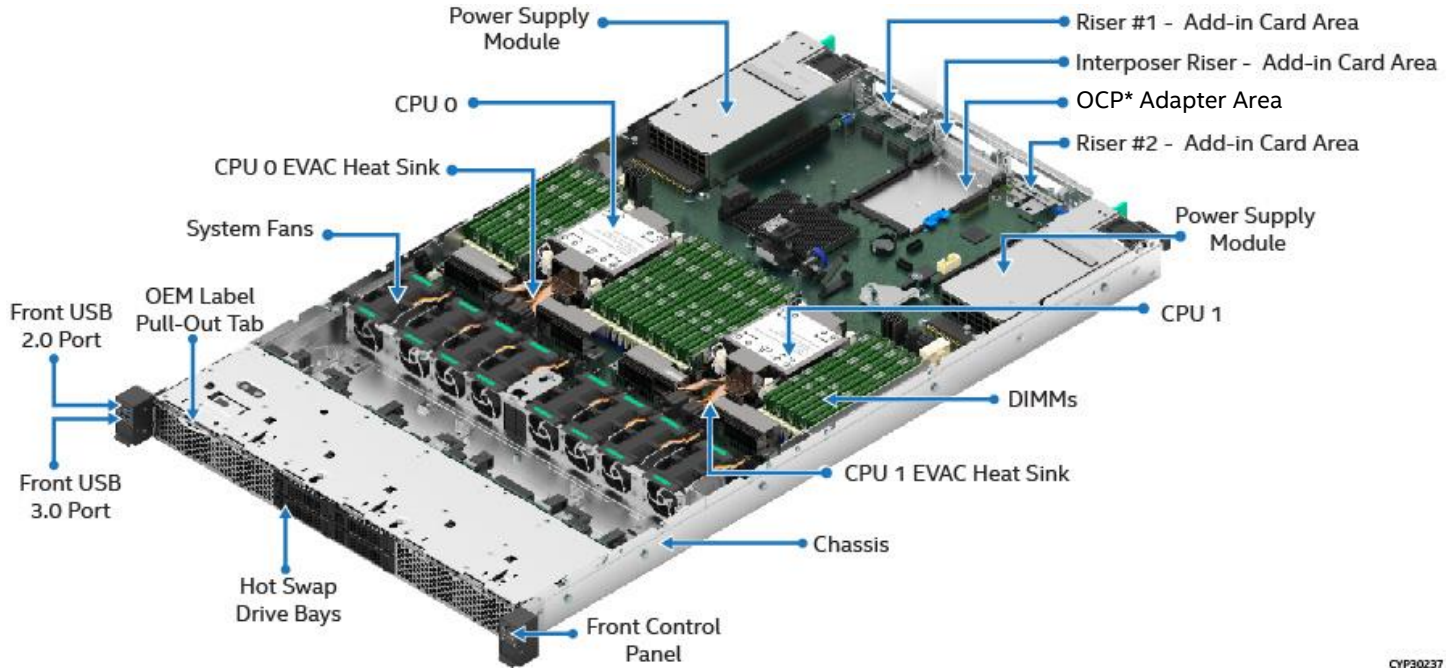

CYP30237

Figure 2. Server System Components Overview

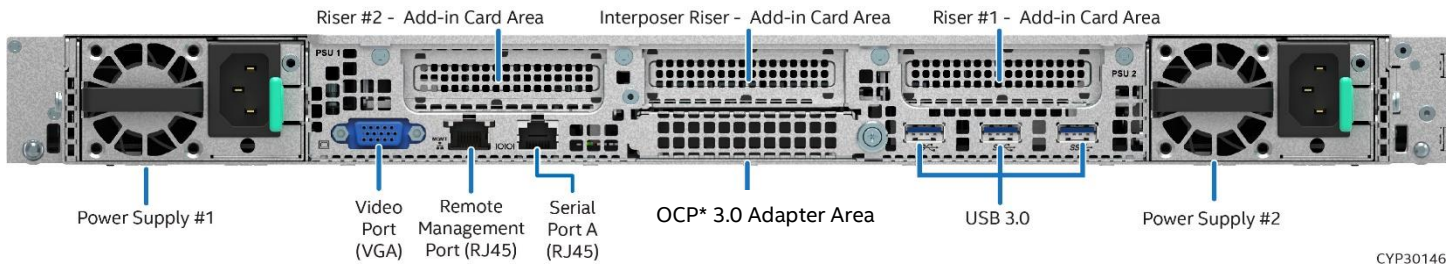

CYP30146

Figure 3. Back Panel Feature Identification



CYP30310

**Figure 4. Front Control Panel Feature Identification**

## 2.3 Front Drive Bay Options



**Figure 5. 4 x 2.5" Front Drive Bay Configuration – M50CYP1UR204**



**Figure 6. 12 x 2.5" Front Drive Bay Configuration – M50CYP1UR212**

## 2.4 Server Board Features

The architecture of the Intel® Server Board M50CYP2SB1U was developed around the integrated features and functions of the 3<sup>rd</sup> Gen Intel® Xeon® Scalable processor family, Intel® C621A chipset (PCH), and ASPEED® AST2500 baseboard management controller (BMC).

Figure 7 provides an overview of the server system architecture, showing the features and interconnects of the major subsystem components. Figure 8 provides a general overview of the physical server board, identifying key feature and component locations.



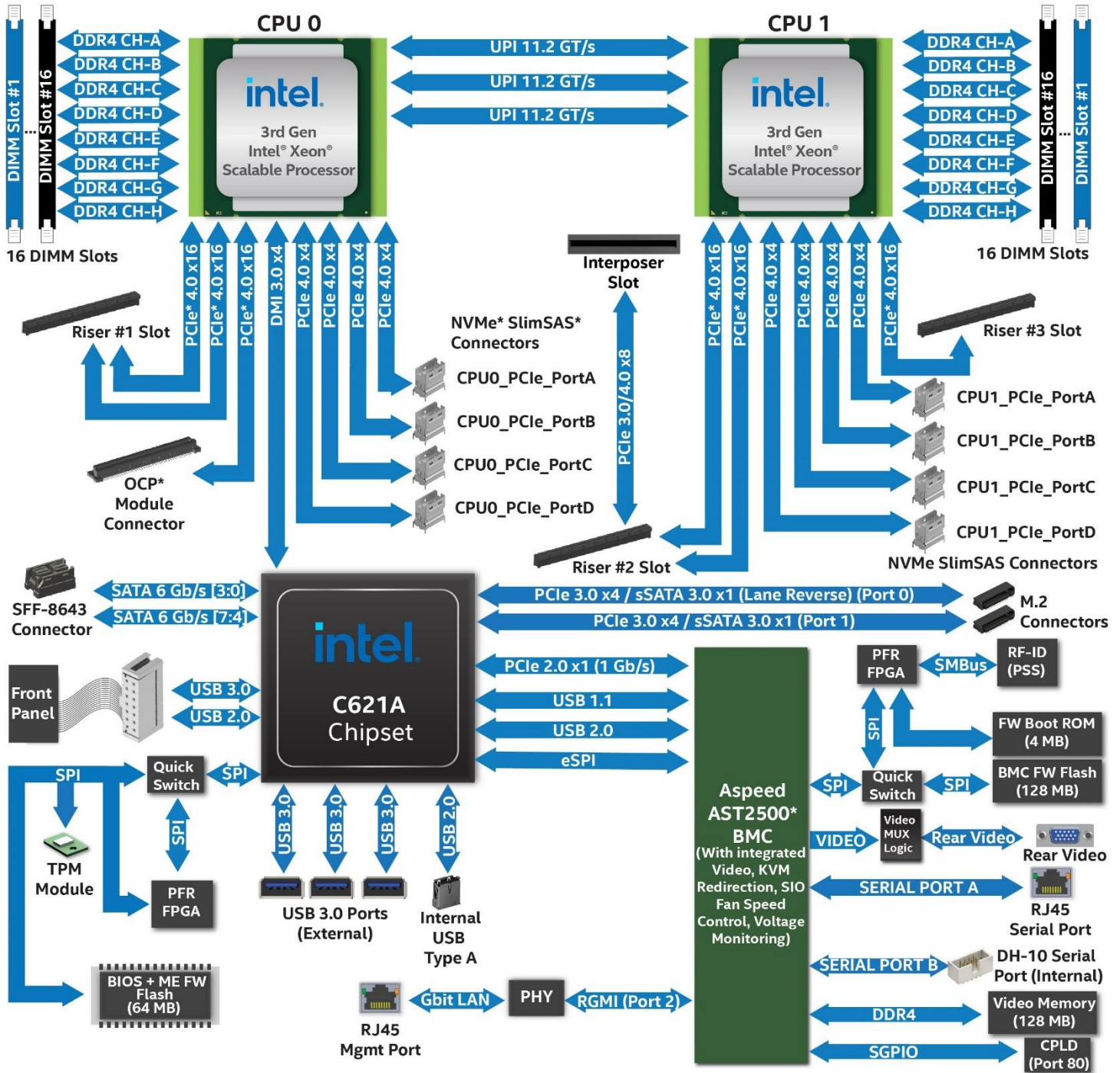
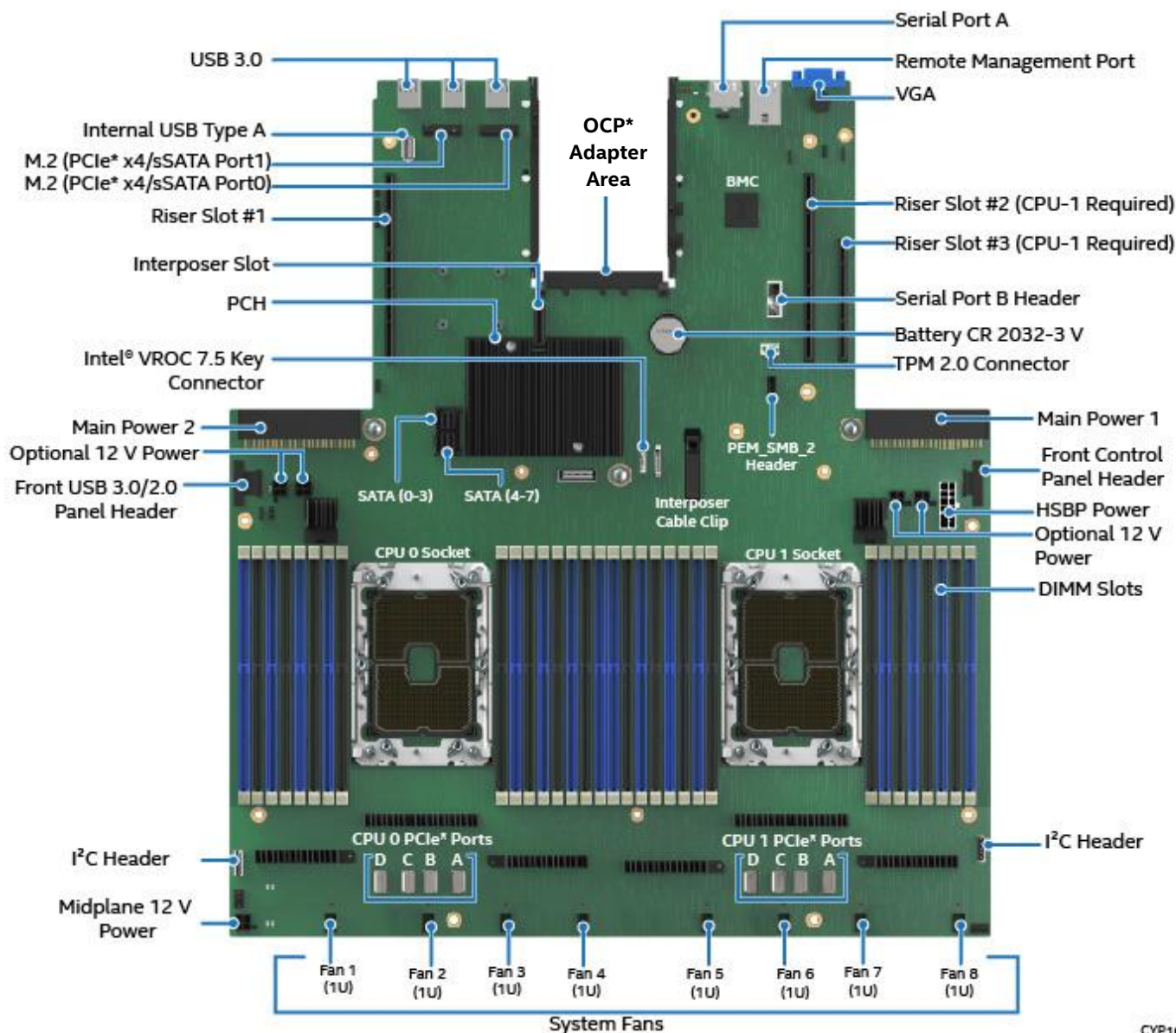

Figure 7. Intel® Server Board M50CYP2SB1U Architectural Block Diagram



CYP100514

**Figure 8. Intel® Server Board M50CYP2SB1U Component / Feature Identification**

The following two figures identify Light Guided Diagnostic LEDs found on the server board. For more information on Intel® Light-Guided Diagnostics, see [Chapter 10](#).

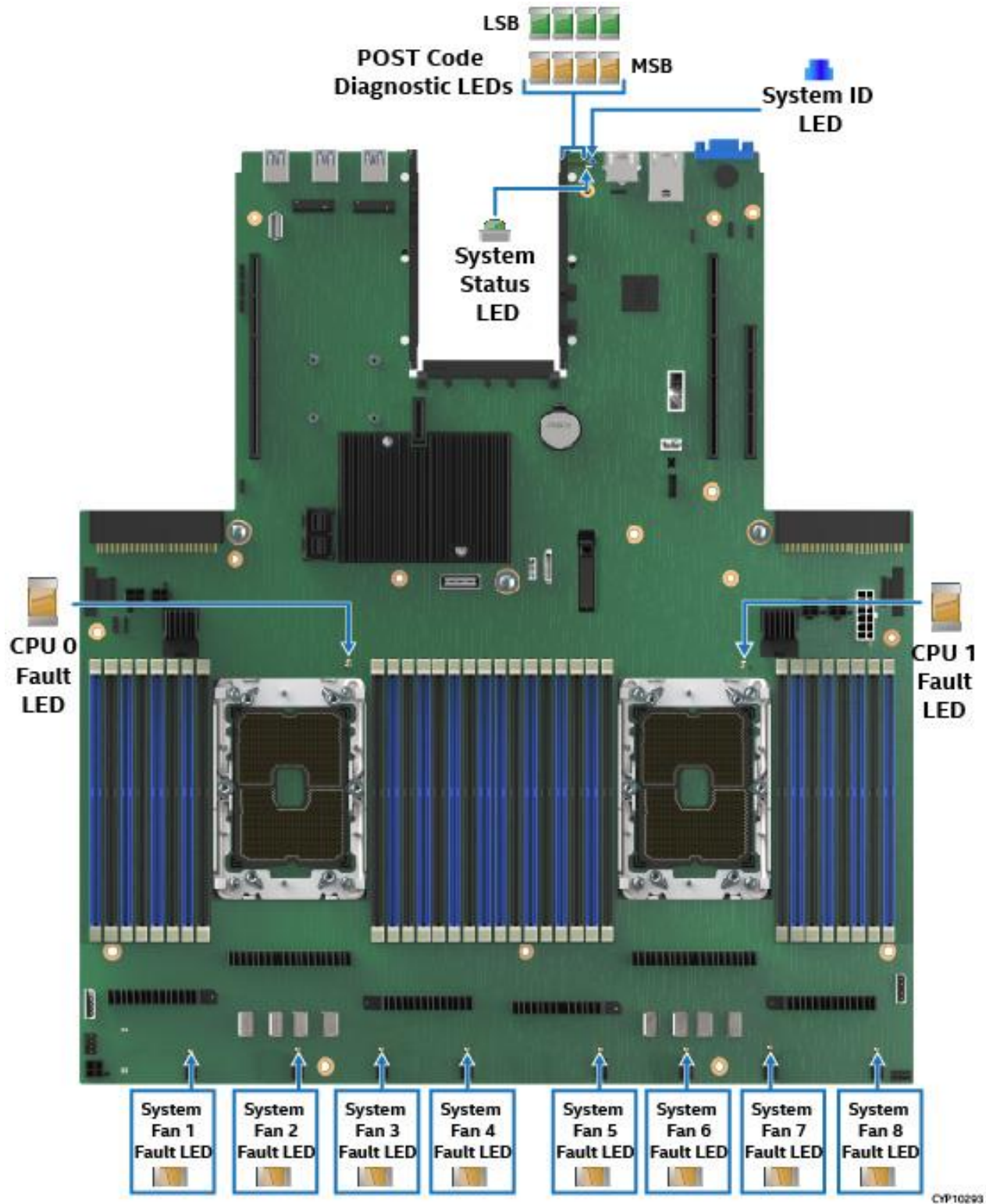
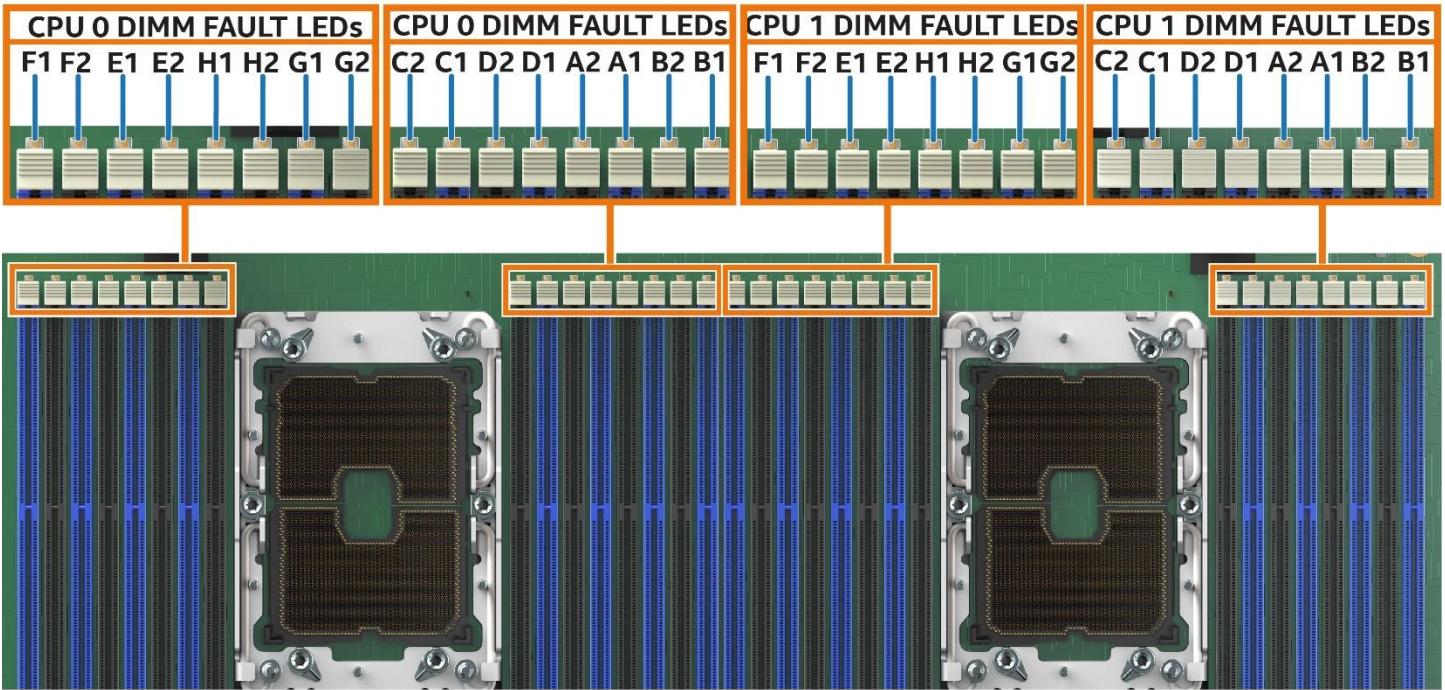

Figure 9. Intel® Light-Guided Diagnostics – LED Identification





CYP10042

Figure 10. Intel® Light-Guided Diagnostics – DIMM Fault LEDs

The server board includes several jumper blocks (see Figure 11) that are used to configure, protect, or recover specific features of the server board. For more information on the jumpers, see the *Intel® Server Board M50CYP2SB Family Technical Product Specification (TPS)*.

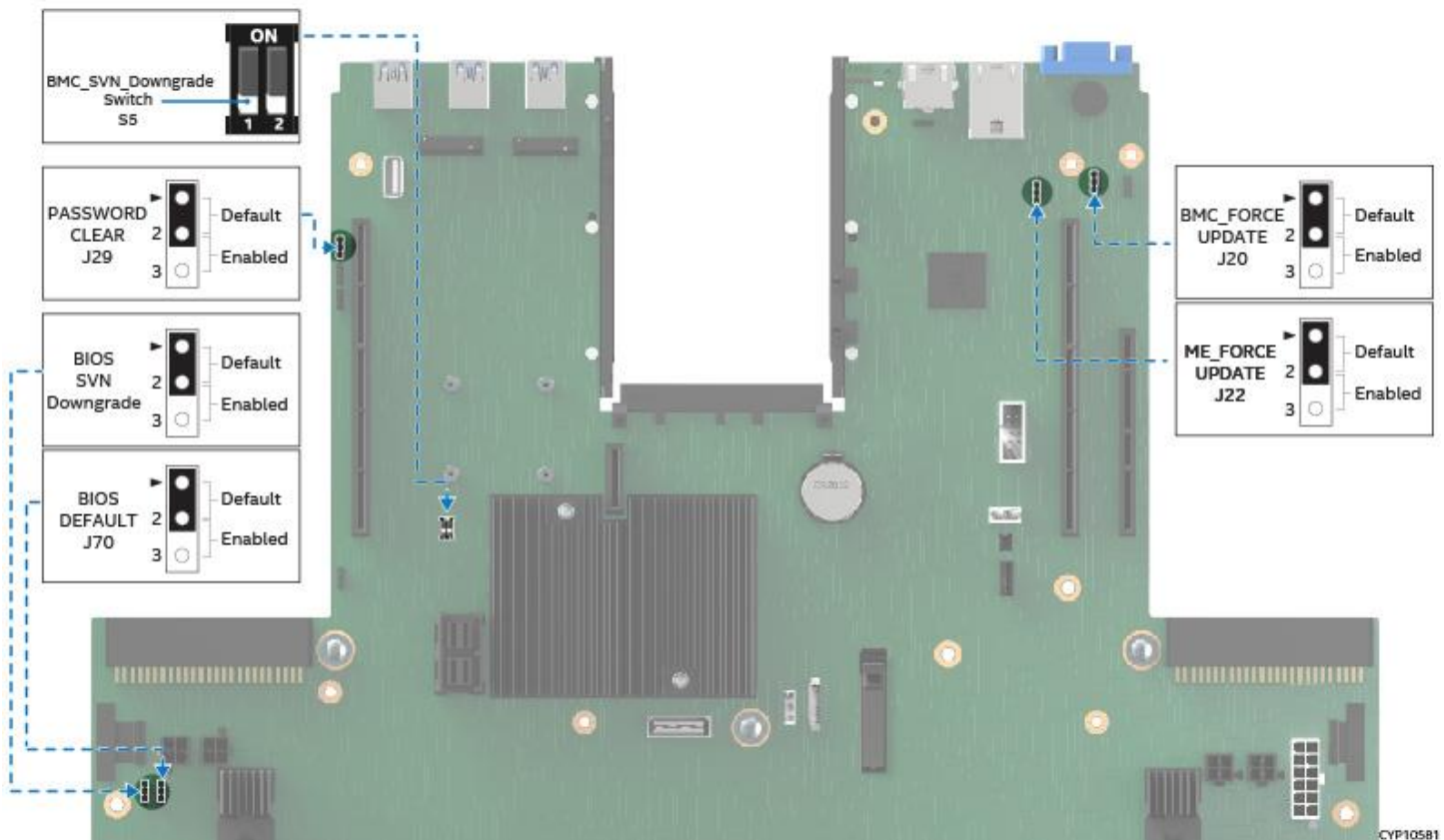

CYP10581

Figure 11. System Configuration and Recovery Jumpers

## 2.5 System Dimensional Data

The following sections provide chassis dimensional data for all supported system configurations within the Intel® Server System M50CYP1UR family.

### 2.5.1 Chassis Dimensions

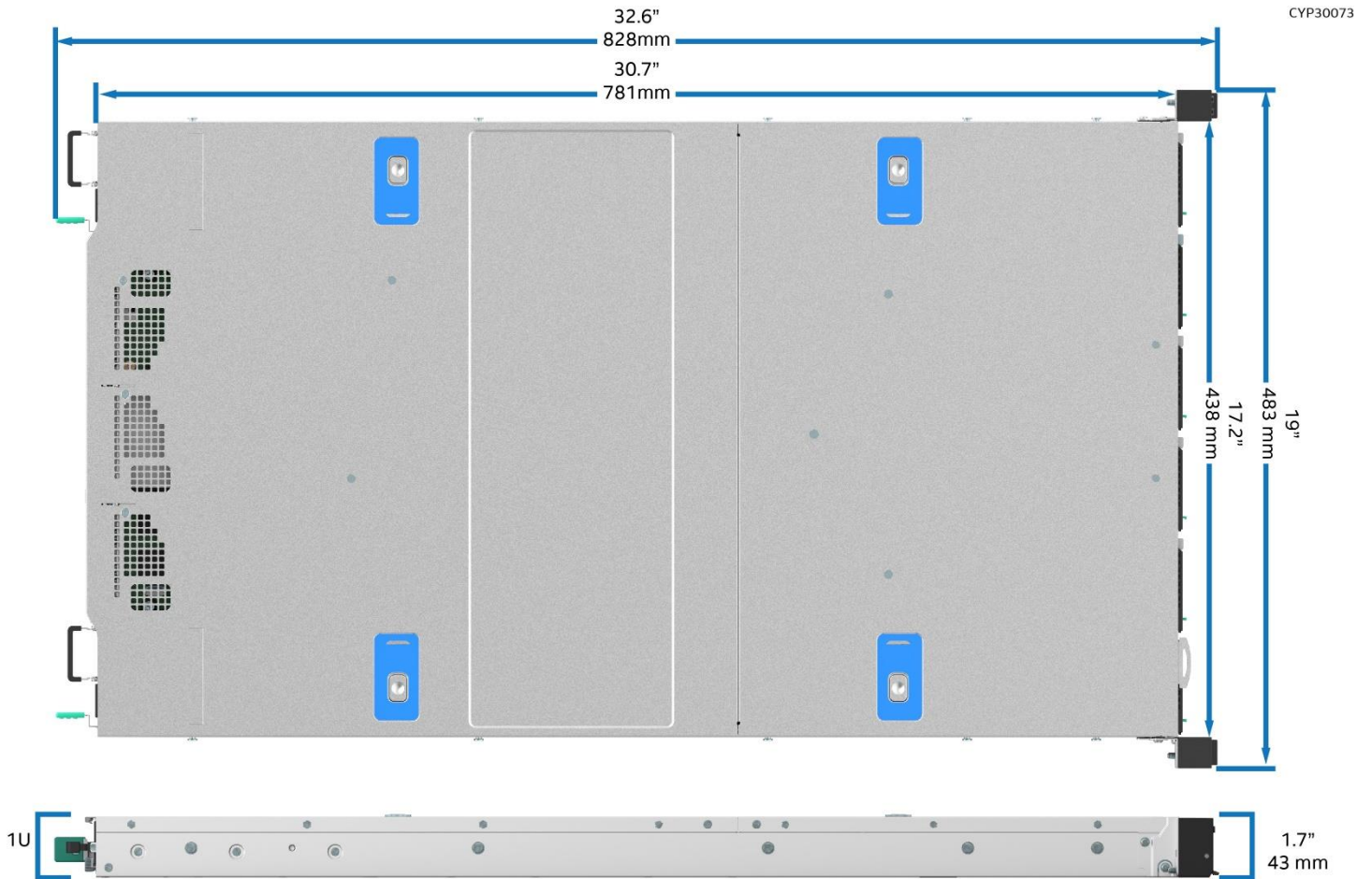

Figure 12. Chassis Dimensions



### 2.5.2 Label Emboss Dimensions

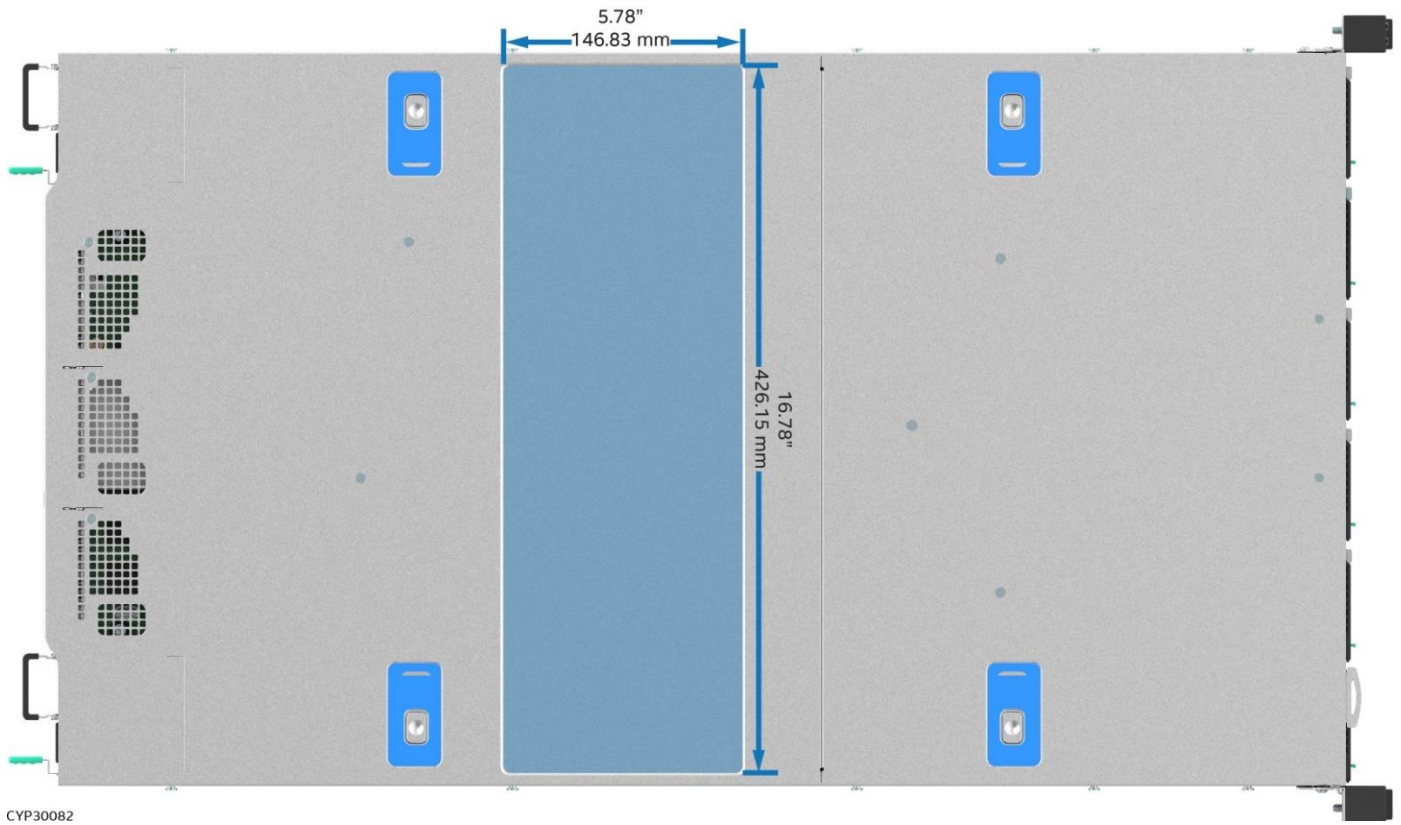

Figure 13. Label Emboss Dimensions

### 2.5.3 Pull-Out Tab Label Emboss Dimensions

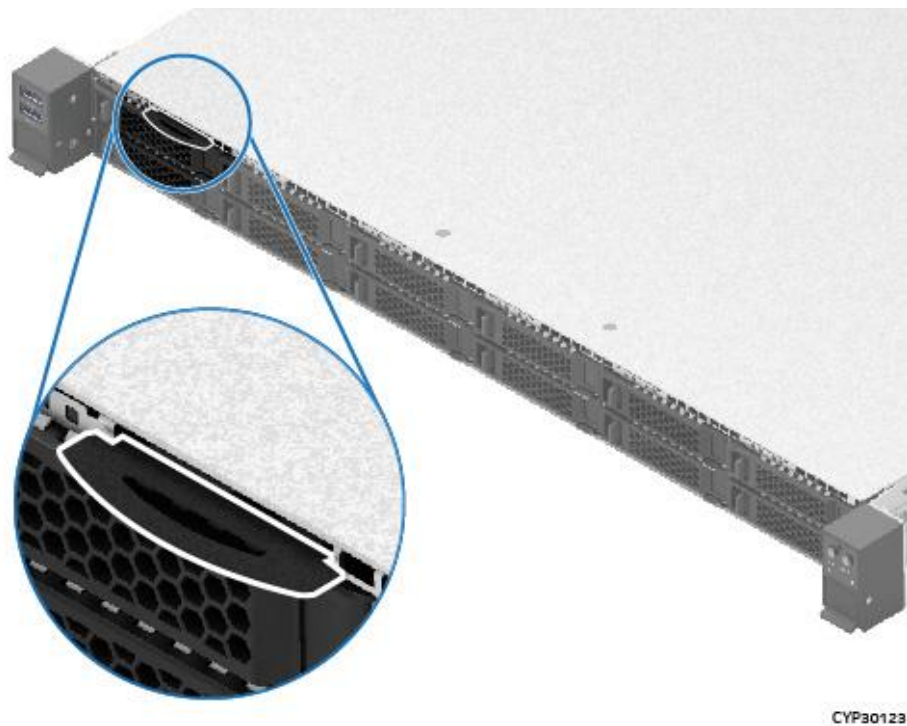
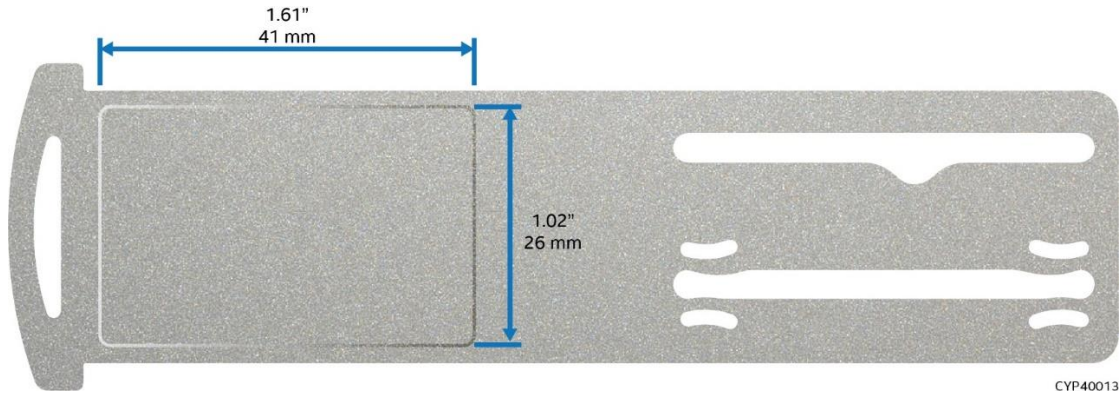

Figure 14. Pull-out Tab Location

The following figure shows pull-out tab label emboss dimensions.



**Figure 15. Pull-out Fab Label Emboss Dimensions**

## 2.6 System Top Cover Usage

The system top cover consists of two panels – one over the front half of the system and one over the back half of the system. To maintain system thermals, both top cover panels must always be in place when the system is operational.

The system ships from the factory with the front system cover and back system cover screwed to the chassis as shown in the following figure. A total of four screws, one on each side of the front cover and one on each side of the back cover, need to be removed to detach each top cover panel from the chassis.

Removal of both top cover panels is necessary when installing or replacing any system component within the server chassis. Once the shipping screws are removed, top cover panel removal and installation are tool-less processes.

---

**Shipping Note:** When transporting the server system, Intel recommends installing the four top cover screws before shipping.

---



**Figure 16. System Top Cover Shipping Screws**

When removing a top cover panel, while pushing down on both the left and right buttons of the given top panel (see Letter A in the following figure), slide the top cover panel towards the front (front panel) or back (back panel) of the chassis (see Letter B).

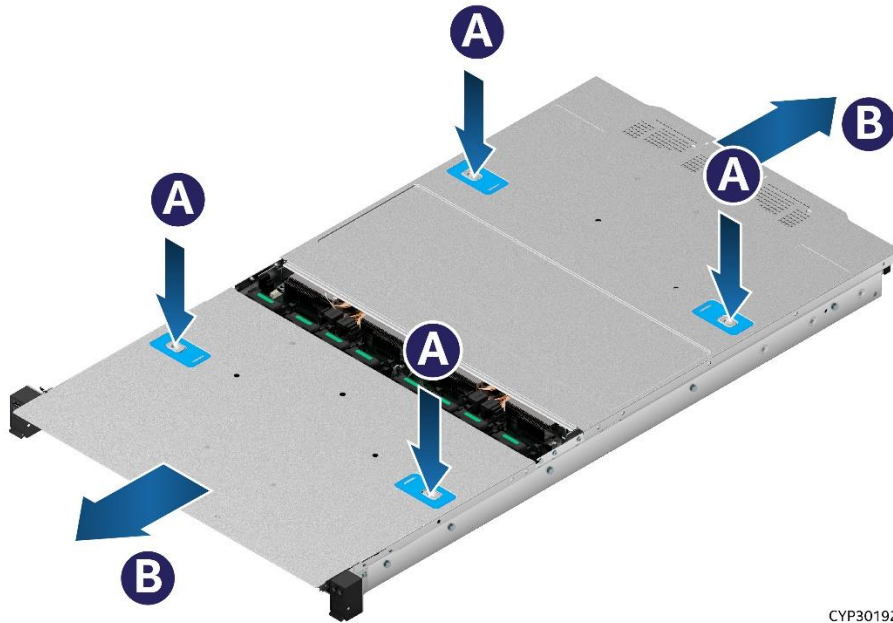

CYP30192

**Figure 17. System Top Cover Removal**

When installing a top cover panel, align the set the top cover panel onto the chassis (see Letter A in the following figure) and slide it inwards until it locks into place.

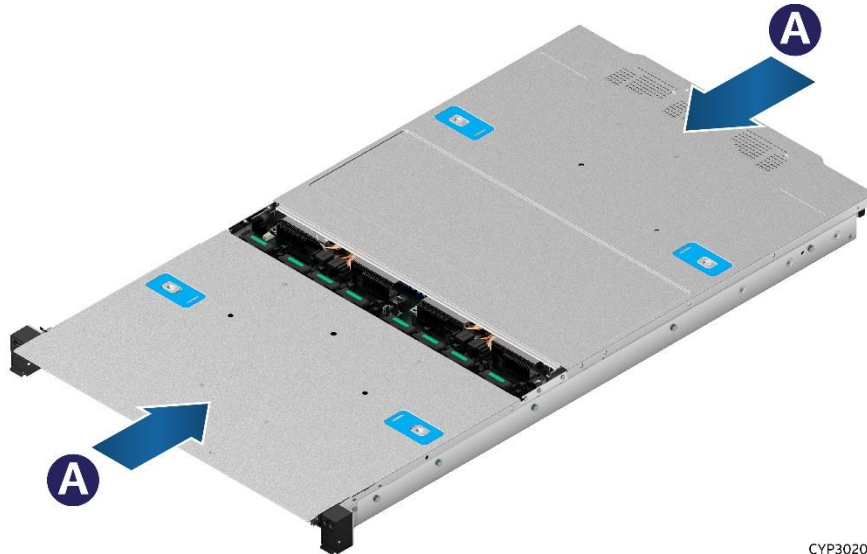

CYP30203

**Figure 18. System Top Cover Installation**

For more information, see the *Intel® Server System M50CYP1UR Family System Integration and Service Guide*.



## 2.7 System Cable Routing Channels

All cables routed to the front drive bay of the server system are routed through the right, in-between the cable walls and the chassis side walls, except cables from the server board SlimSAS connectors. These cables must be routed under the fan assembly. No cables should be routed above the processors or DIMMs.

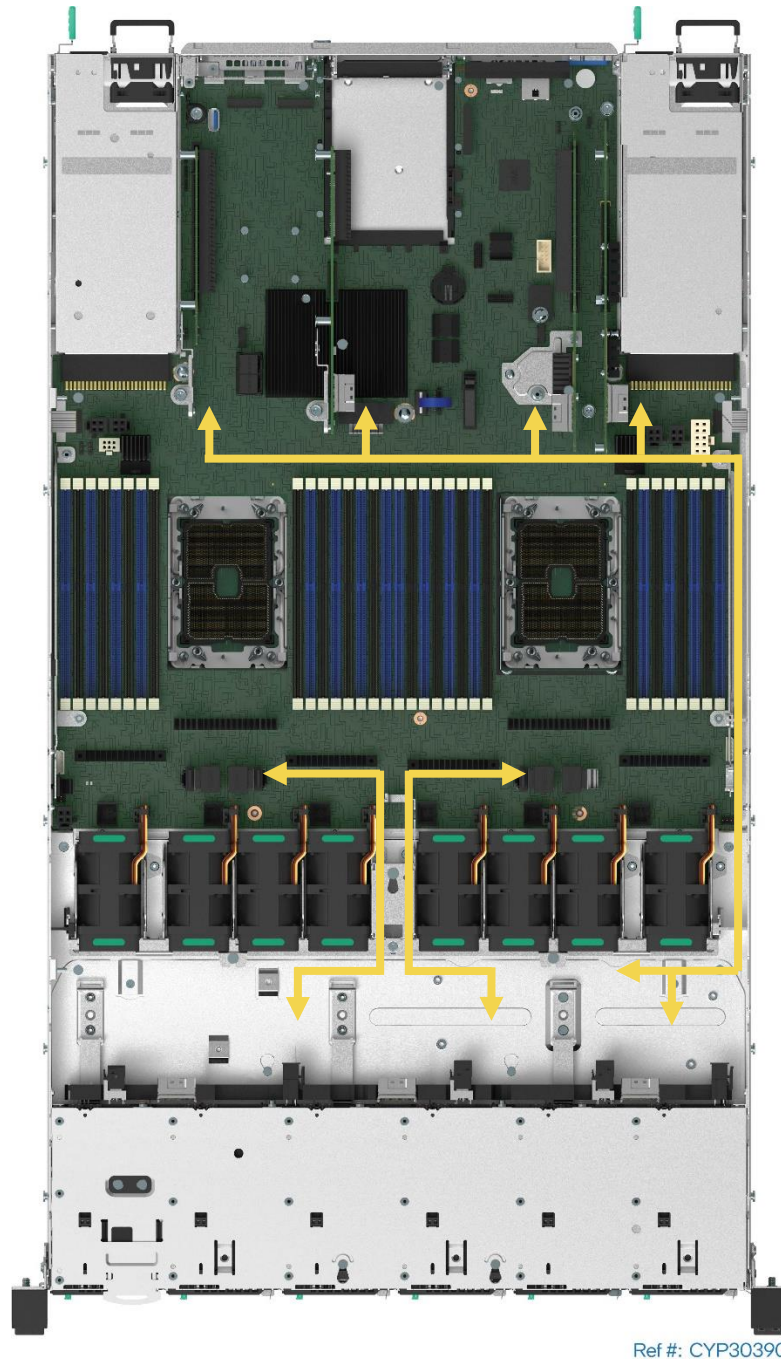

**Figure 19. System Cable Routing Channels**

## 2.8 Available Rack and Cabinet Mounting Kit Options

**Advisory Note:** Available rack and cabinet mounting kits are not designed to support shipment of the server system while installed in a rack. If you choose to do so, Intel advises verification of your shipping configuration with appropriate shock and vibration testing before shipment. Intel does not perform shipping tests that cover the complex combination of unique rack offerings and custom packaging options.

**Caution:** Exceeding the specified maximum weight limit of a given rail kit or misalignment of the server in the rack may result in failure of the rack rails, damaging the system or causing personal injury. Using two people or the use of a mechanical assist tool to install and align the server into the rack is highly recommended.

- **CYPHALFEXTRAIL** –Value Rack Mount Rail Kit
  - 1U, 2U compatible
  - Tool-less chassis attachment
  - Tools required to attach rails to rack
  - Rack installation front and rear post distance adjustment from 660 mm to 838 mm
  - 560 mm travel distance
  - Half extension from rack
  - 31 kg (68.34 lbs.) maximum support weight
  - No support for Cable Management Arm
- **CYPFULLEXTRAIL** – Premium Rail Kit with cable management arm (CMA) support
  - 1U, 2U compatible
  - Tool-less chassis attachment
  - Tool-less installation to rack
  - Rack installation front and rear post distance adjustment from 623mm ~ 942mm
  - 820 mm travel distance
  - Full extension from rack
  - 31 Kgs (68.34 lbs.) maximum supported weight
  - Support for Cable Management Arm AXXCMA2
- **AXXCMA2** – Cable Management Arm (supports **CYPFULLEXTRAIL** only)

## 2.9 System Level Environmental Limits

The following table lists the system level operating and non-operating environmental limits.

**Table 3. System Environmental Limits Summary**

Parameter		Limits
Temperature	Operating	ASHRAE Class A2 – Continuous Operation. 10–35 °C (50–95 °F) with the maximum rate of change not to exceed 10 °C per hour. ** ASHRAE Class A3 – Includes operation up to 40 °C for up to 900 hrs per year. ** ASHRAE Class A4 – Includes operation up to 45 °C for up to 90 hrs per year. **
	Non-Operating	-40–70 °C (-40–158 °F)
Altitude	Operating	Support operation up to 3050 m (10,006 feet) with ASHRAE class de-ratings.
Humidity	Shipping	50% to 90%, non-condensing with a maximum wet bulb of 28 °C (at temperatures 25–35 °C)
Shock	Operating	Half sine, 2 g, 11 msec
	Unpackaged	Trapezoidal, 25 g, velocity change is based on packaged weight
	Packaged	ISTA (International Safe Transit Association) Test Procedure 3A 2008

Parameter		Limits			
<b>Vibration</b>	Unpackaged	5–500 Hz, 2.20 g RMS random			
	Packaged	ISTA (International Safe Transit Association) Test Procedure 3A 2008			
<b>AC-DC</b>	Voltage	90–140 V (Rated 100–127 V) and 180–264 V (rated 200–240 V)			
	Frequency	47–63 Hz (rated 50/60 Hz)			
	Source Interrupt	No loss of data for power line drop-out of 12 msec			
	Surge Non-operating and operating	Unidirectional			
	Line to earth Only	AC Leads	2.0 kV		
	I/O Leads	1.0 kV			
	DC Leads	0.5 kV			
<b>ESD</b>	Air Discharged	12.0 kV			
	Contact Discharge	8.0 kV			
<b>Acoustics Sound Power Measured</b>	Power	<300 W	≥300 W	≥600 W	≥1000 W
	Servers/Rack Mount Sound Power Level	7.0 dBA	7.0 dBA	7.0 dBA	7.0 dBA

**Note:** \*\* For system configuration requirements and limitations, refer to [Appendix E](#) in this document or the *Intel® Server M50CYP Power Budget and Thermal Configuration Tool*.

**Disclaimer:** Intel Corporation server systems support add-in peripherals and contain several high-density Very Large Scale Integration (VLSI) and power delivery components that need adequate airflow to cool. Intel ensures through its own chassis development and testing that, when Intel server building blocks are used together, the fully integrated system will meet the intended thermal requirements of these components. Intel Corporation cannot be held responsible if components fail or the server board does not operate correctly when used outside any of its published operating or non-operating limits.

## 2.10 System Packaging

The original Intel packaging is designed to provide protection to a fully configured system and tested to meet International Safe Transit Association (ISTA) Test Procedure 3A (2008). The packaging is designed to be reused for shipment after system integration has been completed.

The original packaging includes two layers of boxes – an inner box and the outer shipping box – and various protective inner packaging components. The boxes and packaging components are designed to function together as a protective packaging system. When reused, all of the original packaging material must be used, including both boxes and each inner packaging component. In addition, all inner packaging components must be reinstalled in the proper location to ensure adequate protection of the system for subsequent shipment.

**Note:** The design of the inner packaging components does not prevent improper placement within the packaging assembly. Only one correct packaging assembly allows the package to meet the ISTA Test Procedure 3A (2008) limits. For complete packaging assembly instructions, see the *Intel® Server System M50CYP1UR Family System Integration and Service Guide*.

Failure to follow the specified packaging assembly instructions may result in damage to the system during shipment.

The 1U shipping box dimensions are:

- Outer shipping box external dimensions
  - Length: 994 mm
  - Width: 592 mm
  - Height: 300 mm
- Inner box internal dimension
  - Length: 964 mm
  - Width: 562 mm
  - Height: 242 mm

---

**Note:** See the *Intel® Server M50CYP Family Configuration Guide* for product weight information associated with each supported system configuration.

---

### 3. Processor Support

The Intel® Server System M50CYP1UR family includes two Socket-P4 LGA4189 processor sockets compatible with the 3<sup>rd</sup> Gen Intel® Xeon® Scalable processor family.

**Note:** Previous generations Intel® Xeon® processor and Intel® Xeon® Scalable processor families and their supported processor heat sinks are not compatible with server boards described in this document.

#### 3.1 Processor Heat Sink Module (PHM) Assembly and Processor Socket Assembly

This generation of the server system requires that the processor be pre-assembled to the heat sink before installation onto the server board. The processor heat sink assembly is commonly referred to as the Processor Heat Sink Module (PHM). The PHM assembly is installed onto the processor socket assembly (referred to as the loading mechanism) on the server board.

The Intel® Server System M50CYP1UR family supports two types of heat sinks as shown in the following figure: standard 1U heat sink and Enhanced Volume Air Cooling (EVAC) heat sink. The type of heat sink used depends on the system thermal requirements. The 2.5" x4 front drive system must use the EVAC heat sink. The 2.5" x12 front drive system must use the standard 1U heat sink.

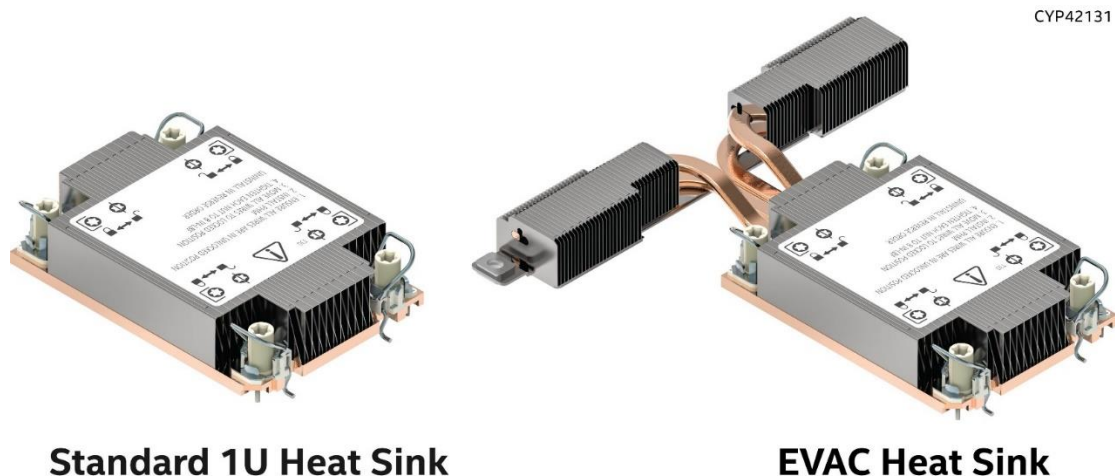

**Figure 20. Supported Processor Heat Sinks**

The following figure identifies each component associated with the PHM and processor socket assembly. The components needed are the same for both heat sink types. The Enhanced Volume Air Cooling (EVAC) heat sink is shown in the figure.

**Note:** [Figure 21](#) identifies the PHM components, not the processor installation process.

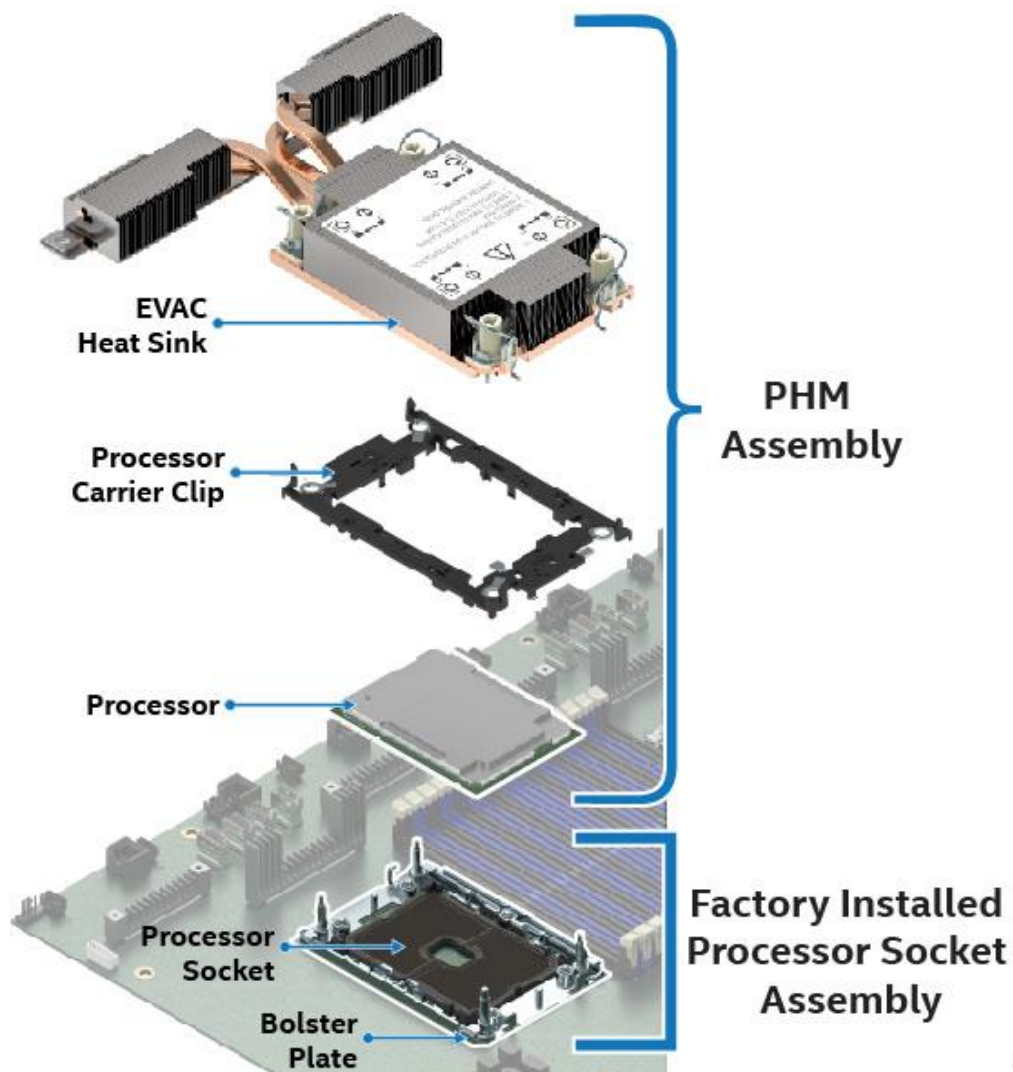

Figure 21. PHM Components and Processor Socket Reference Diagram

CYP41005

---

**Note:** For detailed processor assembly and installation instructions, see the *Intel® Server System M50CYP1UR Family Integration and Service Guide*.

---

### 3.2 Processor Thermal Design Power (TDP) Support

To allow optimal operation and long-term reliability of Intel® Server System M50CYP1UR based systems, the processor must remain within the defined minimum and maximum case temperature ( $T_{CASE}$ ) specifications, using Intel-defined heat sinks. Thermal solutions not designed to provide sufficient thermal capability may affect the long-term reliability of the processor and system. In the Intel® Server System M50CYP1UR104 based systems, the maximum supported processor TDP is up to and including 270 W. In the Intel® Server System M50CYP1UR112 based systems, the maximum supported processor TDP is up to and including 205 W.

---

**Note:** The maximum supported processor TDP depends on system configuration. For more information, see [Appendix E](#) for Thermal Compatibility.

---



### 3.3 Processor Family Overview

The Intel® Server System M50CYP1UR family supports the 3<sup>rd</sup> Gen Intel® Xeon® Scalable processor family. Processor shelves within the family are identified as shown in the following figure.

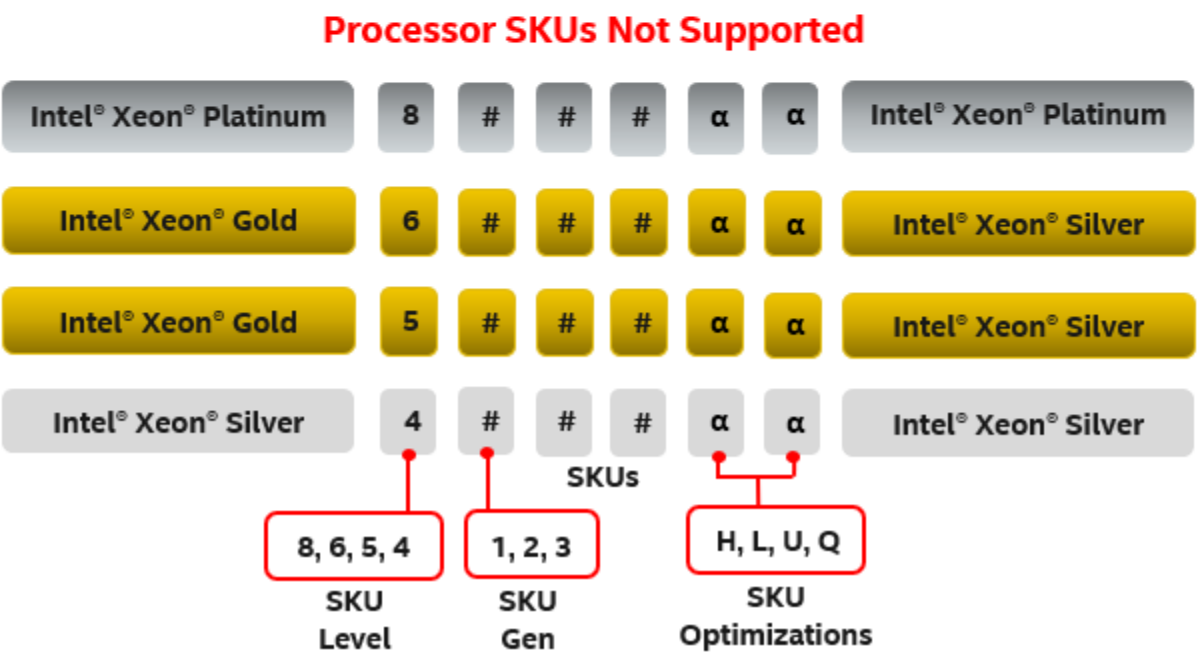
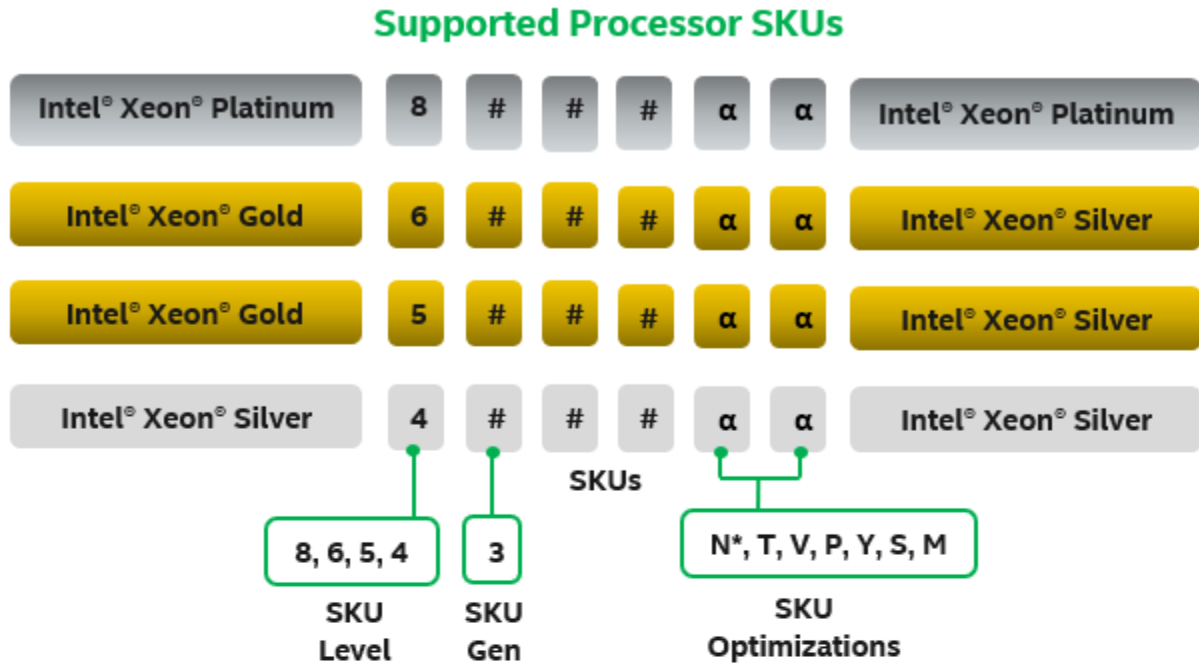

Figure 22. 3<sup>rd</sup> Gen Intel® Xeon® Scalable Processor Identification

**Note:** Supported 3<sup>rd</sup> Gen Intel® Xeon® Scalable processor SKUs must Not end in (H), (L), (U), or (Q). All other processor SKUs are supported.

\* **Note:** The 8351N SKU is a 1-socket optimized SKU and is not supported on the Intel® Server System M50CYP1UR family.

**Table 4. 3<sup>rd</sup> Gen Intel® Xeon® Scalable Processor Family Feature Comparison**

Feature	Platinum 8300 Processors	Gold 6300 Processors	Gold 5300 Processors	Silver 4300 Processors
# of Intel® UPI Links	3	3	3	2
Intel® UPI Speed	11.2 GT/s	11.2 GT/s	11.2 GT/s	10.4 GT/s
Supported Topologies	2S-2UPI 2S-3UPI	2S-2UPI 2S-3UPI	2S-2UPI 2S-3UPI	2S-2UPI
Node Controller Support	No	No	No	No
RAS Capability	Advanced	Advanced	Advanced	Standard
Intel® Turbo Boost Technology	Yes	Yes	Yes	Yes
Intel® HT Technology	Yes	Yes	Yes	Yes
Intel® AVX-512 ISA Support	Yes	Yes	Yes	Yes
Intel® AVX-512 - # of 512b FMA Units	2	2	2	2
# of PCIe* Lanes	64	64	64	64
Intel® VMD	Yes	Yes	Yes	Yes

**Note:** Features may vary between processor SKUs.

Reference 3<sup>rd</sup> Gen Intel® Xeon® Scalable processor specification sheets and product briefs for additional information.

### 3.3.1 Supported Technologies

The 3<sup>rd</sup> Gen Intel® Xeon® Scalable processors combine several key system components into a single processor package including the processor cores, Integrated Memory Controller (IMC), and Integrated IO Module.

The supported technologies for the processor family include:

- Intel® Ultra Path Interconnect (Intel® UPI) – supports up to 11.2 GT/s
- Intel® Speed Shift Technology
- Intel® 64 Architecture
- Enhanced Intel® SpeedStep® Technology
- Intel® Turbo Boost Technology 2.0
- Intel® Hyper-Threading Technology (Intel® HT Technology)
- Intel® Virtualization Technology (Intel® VT-x)
- Intel® Virtualization Technology for Directed I/O (Intel® VT-d)
- Execute Disable Bit
- Intel® Trusted Execution Technology (Intel® TXT)
- Intel® Advanced Vector Extensions (Intel® AVX-512)
- Intel® Advanced Encryption Standard New Instructions (Intel® AES-NI)
- Intel® Deep Learning through VNNI
- Intel® Speed Select Technology on select processor SKUs
- Intel® Resource Director Technology



## 3.4 Processor Population Rules

---

**Note:** The server board may support dual-processor configurations consisting of different processors that meet the following defined criteria. However, Intel does not perform validation testing of this configuration. In addition, Intel does not ensure that a server system configured with unmatched processors will operate reliably. The system BIOS attempts to operate with processors that are not matched but are generally compatible. For optimal system performance in dual-processor configurations, Intel recommends that identical processors be installed.

---

When using a single processor configuration, the processor must be installed into the processor socket labeled "CPU\_0".

---

**Note:** Some server board features may not be functional unless a second processor is installed. See [Figure 7](#).

---

When two processors are installed, the following population rules apply:

- Both processors must have identical extended family, extended model number and processor type
- Both processors must have the same number of cores
- Both processors must have the same cache sizes for all levels of processor cache memory
- Both processors must support identical DDR4 memory frequencies

---

**Note:** Processors with different steppings can be mixed in a system as long as the rules mentioned above are met.

---

Population rules are applicable to any combination of processors within the 3<sup>rd</sup> Gen Intel® Xeon® Scalable processor family.

For additional information on processor population rules, refer to the *BIOS Firmware External Product Specification (EPS) for the Intel® Server Board D50TNP and M50CYP Families*.

## 4. Memory Support

This chapter describes the architecture that drives the memory subsystem, supported memory types, memory population rules, and supported memory RAS features.

### 4.1 Memory Subsystem Architecture

The Intel® Server System M50CYP1UR family supports up to 32 DDR4 DIMMs, 16 per processor.

The 3<sup>rd</sup> Gen Intel® Xeon® Scalable processors support eight memory channels using four integrated memory controllers (IMCs). Each memory channel is assigned an identifying letter A-H, with each memory channel supporting two DIMM slots—slot 1 (blue slot) and slot 2 (black slot).



Figure 23. Memory Slot Connectivity

### 4.2 Supported Memory

The server system supports standard DDR4 RDIMMs, DDR4 LDRIMMs, and Intel® Optane™ persistent memory 200 series modules.

The server board is designed to support the 3<sup>rd</sup> Generation Intel® Xeon® Scalable processor family and may be populated with a combination of both DDR4 DRAM DIMMs and Intel® Optane™ persistent memory 200 series modules.

---

**Note:** Previous generation Intel® Optane™ persistent memory modules are not supported.

---

Intel® Optane™ persistent memory is an innovative technology that delivers a unique combination of affordable large memory capacity and support for data persistence (non-volatility). It represents a new class of memory and storage technology architected specifically for data center usage. The Intel® Optane™ persistent memory 200 series modules enable higher density (capacity per DIMM) DDR4-compatible memory modules with near-DRAM performance and advanced features not found in standard SDRAM. The persistent memory technology can help boost the performance of data-intensive applications, such as in-memory analytics, databases, content delivery networks, and high-performance computing (HPC).

## 4.2.1 Standard DDR4 DIMM Support

The following figure shows a standard DDR4 DIMM module.

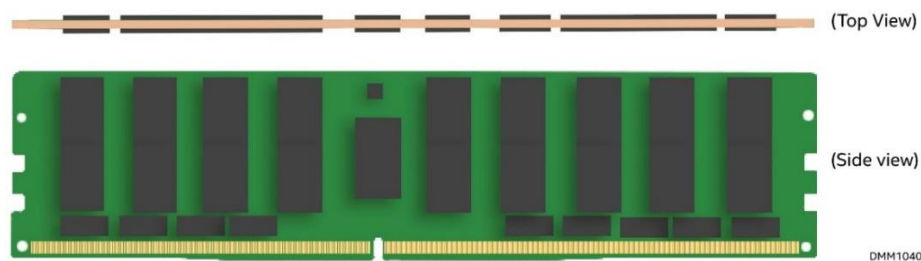

**Figure 24. Standard SDRAM DDR4 DIMM Module**

The server system supports DDR4 DIMMs with the following features:

- All DDR4 DIMMs must support ECC
- Registered DDR4 (RDIMM), 3DS-RDIMM, Load Reduced DDR4 (LRDIMM), 3DS-LRDIMM  
**Note:** 3DS = 3 Dimensional Stacking
- RDIMMs and LRDIMMs with thermal sensor On DIMM (TSOD)
- DIMM speeds of up to 3200 MT/s (for 2 DPC)
- DIMM capacities of 8 GB, 16 GB, 32 GB, 64 GB, 128 GB, and 256 GB
- RDIMMs organized as Single Rank (SR), Dual Rank (DR)
- 3DS-RDIMM organized as Quad Rank (QR), or Oct Rank (OR)
- LRDIMMs organized as Quad Rank (QR)
- 3DS-LRDIMM organized as Quad Rank (QR), or Oct Rank (OR)

The following table lists the DIMM support guidelines.

**Table 5. Supported DDR4 DIMM Memory**

Type	Ranks per DIMM and Data Width	DIMM Capacity (GB)		Maximum Speed (MT/s) at 1.2 V	
		8 Gb DDR4 Density	16 Gb DDR4 Density	1 DPC	2 DPC
RDIMM	SR x8	8	16	3200	3200 <sup>1</sup>
	SR x4	16	32	3200	3200 <sup>1</sup>
	DR x8	16	32	3200	3200 <sup>1</sup>
	DR x4	32	64	3200	3200 <sup>1</sup>
3DS-RDIMM	QR/OR x4	64 (2H) 128 (4H)	128 (2H) 256 (4H)	3200	3200 <sup>1</sup>
LRDIMM	QR x4	64	128	3200	3200
3DS-LRDIMM	QR/OR x4	128 (4H)	128 (2H) 256 (4H)	3200	3200

**Note:** <sup>1</sup> Specification applies only to memory chips mounted by surface mounted technology (SMT) method. For plated through hole (PTH) mounted method, the maximum speed is 2933 MT/s. Refer to the DIMM datasheets for more information.

**Note:** SR = Single Rank, DR = Dual Rank, QR = Quad Rank, OR = Oct Rank, H = Stack Height

**Table 6. Maximum Supported Standard DDR4 DIMM Speeds by Processor Shelf**

Processor Family	Maximum DIMM Speed (MT/s) by processor Shelf			
	Platinum 8300 Processors	Gold 6300 Processors	Gold 5300 Processors	Silver 4300 Processors
3 <sup>rd</sup> Gen Intel® Xeon® Scalable processor family	3200	3200	2933	2666

**Note:** Specification applies only to memory chips mounted by surface mounted technology (SMT) method. Refer to the DIMM datasheets for more information.

#### 4.2.2 Intel® Optane™ Persistent Memory 200 Series Module Support

The processor families support Intel® Optane™ persistent memory 200 series modules. The following figure shows an Intel® Optane™ persistent memory 200 series module.

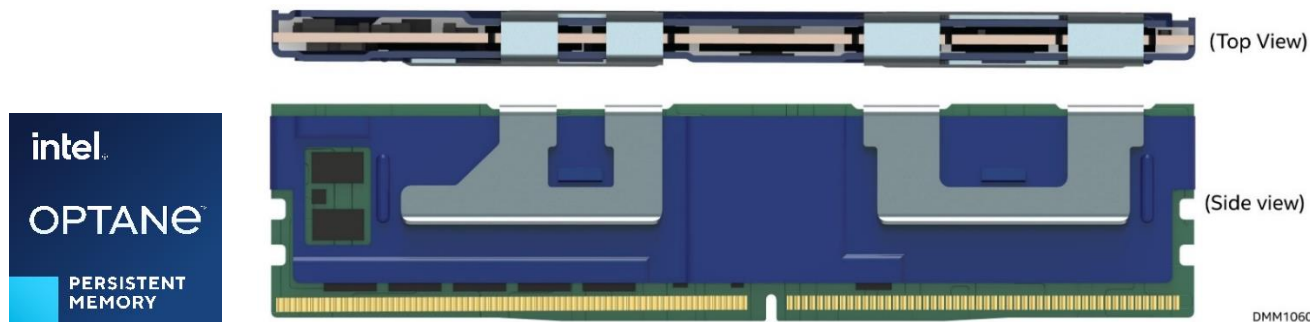

**Figure 25. Intel® Optane™ Persistent Memory 200 series Module**

Intel® Optane™ PMem (persistent memory) is an innovative technology that delivers a unique combination of affordable large memory capacity and data persistence (non-volatility). It represents a new class of memory and storage technology architected specifically for data center usage. Intel® Optane™ PMem 200 series enables higher density (capacity per DIMM) DDR4-compatible memory modules with near-DRAM performance and advanced features not found in standard SDRAM.

The module supports the following features:

- Always-enabled AES-256 encryption
- Cache coherent: like DRAM, contains evicted information from the LLC
- Byte-addressable memory
- Higher endurance than enterprise class SSDs

The module supports the following operating modes:

- Memory mode (MM)
- App Direct (AD) mode

App Direct mode requires both driver and explicit software support. To ensure operating system compatibility, visit <https://www.intel.com/content/www/us/en/architecture-and-technology/optane-memory.html>

##### 4.2.2.1 Intel® Optane™ Persistent Memory 200 Series Module – Memory Mode (MM)

In Memory mode, the standard DDR4 DRAM DIMM acts as a cache for the most frequently accessed data, while Intel® Optane™ persistent memory 200 series modules provide large memory capacity by acting as direct load/store memory. In this mode, applications and operating system are explicitly aware that the Intel® Optane™ persistent memory 200 series is the only type of direct load/store memory in the system. Cache management operations are handled by the integrated memory controller on the Intel® Xeon® Scalable processors. When data is requested from memory, the memory controller first checks the DRAM cache. If the data is present, the response latency is identical to DRAM. If the data is not in the DRAM cache, it is read from

the Intel® Optane™ persistent memory 200 series modules with slightly longer latency. The applications with consistent data retrieval patterns that the memory controller can predict, will have a higher cache hit rate. Data is volatile in Memory mode. It will not be saved in the event of power loss. Persistence is enabled in App Direct mode.

#### 4.2.2.2 Intel® Optane™ Persistent Memory 200 Series Module – App Direct (AD) Mode

In App Direct mode, applications and the operating system are explicitly aware that there are two types of direct load/store memory in the platform. They can direct which type of data read or write is suitable for DRAM DIMM or Intel® Optane™ persistent memory 200 series modules. Operations that require the lowest latency and do not need permanent data storage can be executed on DRAM DIMM, such as database “scratch pads”. Data that needs to be made persistent or structures that are very large can be routed to the Intel® Optane™ persistent memory. The App Direct mode must be used to make data persistent in memory. This mode requires an operating system or virtualization environment enabled with a persistent memory-aware file system.

App Direct mode requires both driver and explicit software support. To ensure operating system compatibility, visit <https://www.intel.com/content/www/us/en/architecture-and-technology/optane-memory.html>.

#### 4.2.2.3 Intel® Optane™ PMem configuration using the <F2> BIOS Setup Utility

Following the installation of Intel® Optane™ PMem devices into the system, the devices need to be configured using the <F2> BIOS Setup utility. The BIOS Setup utility includes several Intel® Optane™ PMem configuration options across multiple BIOS Setup screens. The following illustration provides a BIOS Setup screen navigation directing the user to the main Intel® Optane™ PMem configuration screen.

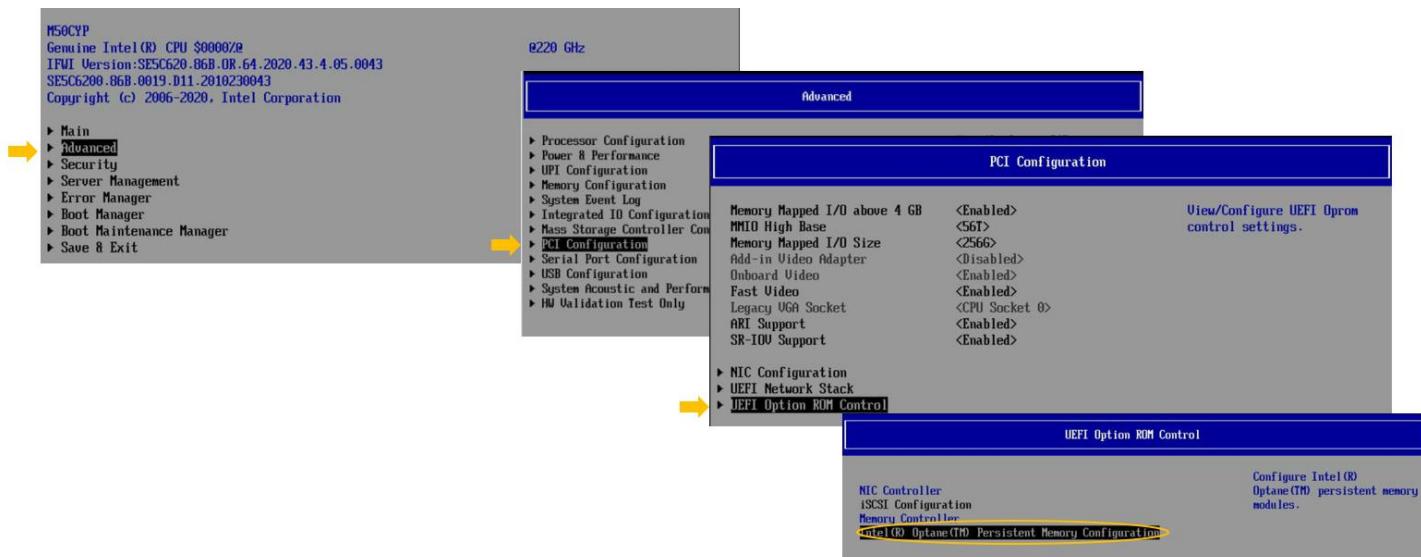

Figure 26. <F2> BIOS Setup Screen Navigation for Intel® Optane™ PMem Setup Options

The main Intel® Optane™ PMem Configuration screen provides links to the various device information and setup screens.



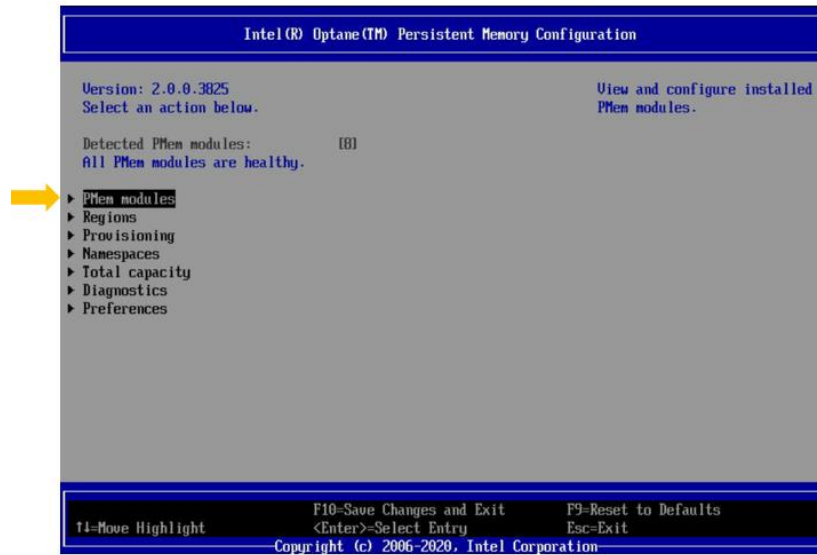

Figure 27. Intel® Optane™ PMem Configuration Menu in <F2> BIOS Setup

### 4.3 Memory Population

In the Intel® Server System M50CYP1UR family, a total of 32 memory slots are provided – two slots per channel and eight channels per processor.

This section provides memory population rules and recommendations for standard DD4 DIMMs, LRDIMMs, and Intel® Optane™ persistent memory 200 series modules. The following figure shows the full board layout for all memory slots on both processor sockets.

**Note:** All black DIMM slots must be populated with either DIMMs or supplied DIMM blanks. All system configurations ship from Intel with DIMM blanks pre-installed. Pre-installed DIMM blanks should only be removed when installing a memory module in its place.

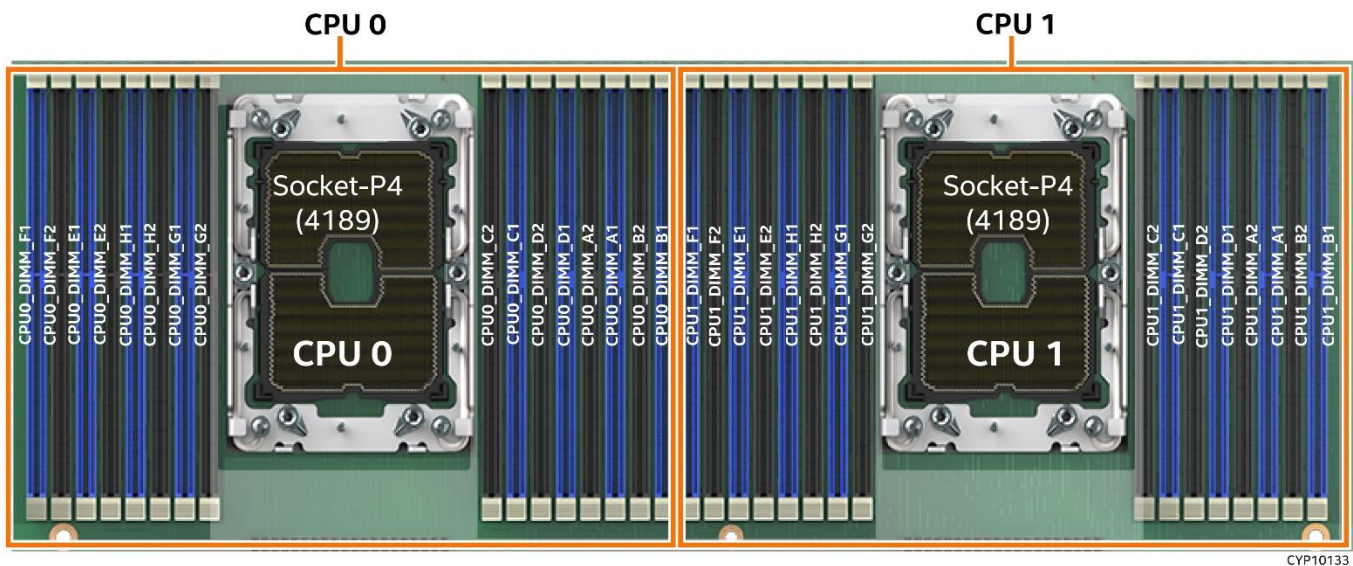

Figure 28. Intel® Server System M50CYP1UR Family Memory Slot Layout

### 4.3.1 DDR4 DIMM Population Rules

#### Intel DDR4 DIMM Support Disclaimer:

Intel validates and will only provide support for system configurations where all installed DDR4 DIMMs have matching “Identical” or “Like” attributes. See [Table 7](#). A system configured concurrently with DDR4 DIMMs from different vendors will be supported by Intel if all other DDR4 “Like” DIMM attributes match.

Intel does not perform system validation testing nor will it provide support for system configurations where all populated DDR4 DIMMs do not have matching “Like” DIMM attributes as listed in [Table 7](#).

Intel will only provide support for Intel server systems configured with DDR4 DIMMs that have been validated by Intel and are listed on Intel’s Tested Memory list for the given Intel server family.

Intel configures and ships pre-integrated L9 server systems. All DDR4 DIMMs within a given L9 server system as shipped by Intel will be identical. All installed DIMMs will have matching attributes as those listed in the “Identical” *DDR4 DIMM4 Attributes* column in [Table 7](#).

When purchasing more than one integrated L9 server system with the same configuration from Intel, Intel reserves the right to use “Like” DIMMs between server systems. At a minimum “Like” DIMMs will have matching DIMM attributes as listed in the table below. However, the DIMM model #, revision #, or vendor may be different.

For warranty replacement, Intel will make every effort to ship back an exact match to the one returned. However, Intel may ship back a validated “Like” DIMM. A “Like” DIMM may be from the same vendor but may not be the same revision # or model #, or it may be an Intel validated DIMM from a different vendor. At a minimum, all “Like” DIMMs shipped from Intel will match attributes of the original part according to the definition of “Like” DIMMs in the following table.

**Table 7. DDR4 DIMM Attributes Table for “Identical” and “Like” DIMMs**

<ul style="list-style-type: none"> <li>• DDR4 DIMMs are considered “Identical” when ALL listed attributes between the DIMMs match</li> <li>• Two or more DDR4 DIMMs are considered “Like” DIMMs when all attributes minus the Vendor, and/or DIMM Part # and/or DIMM Revision#, are the same.</li> </ul>			
Attribute	“Identical” DDR4 DIMM Attributes	“Like” DDR4 DIMM Attributes	Possible DDR4 Attribute Values
Vendor	Match	Maybe Different	Memory Vendor Name
DIMM Part #	Match	Maybe Different	Memory Vendor Part #
DIMM Revision #	Match	Maybe Different	Memory Vendor Part Revision #
SDRAM Type	Match	Match	DDR4
DIMM Type	Match	Match	RDIMM, LRDIMM
Speed (MHz)	Match	Match	2666, 2933, 3200
Voltage	Match	Match	1.2V
DIMM Size (GB)	Match	Match	8GB, 16GB, 32GB, 64GB, 128GB, 256GB
Organization	Match	Match	1Gx72; 2Gx72; 4Gx72; 8Gx72; 16Gx72; 32Gx72
DIMM Rank	Match	Match	1R, 2R, 4R, 8R
DRAM Width	Match	Match	x4, x8
DRAM Density	Match	Match	8Gb, 16Gb

---

**Note:** Although mixed DDR4 DRAM DIMM configurations are supported, Intel only performs platform validation on systems that are configured with identical DIMMs installed.

---

The following memory population rules apply when installing DDR4 DIMMs:

- Mixing rules:
  - Mixing DDR4 DIMMs of different frequencies and latencies is not supported within or across processors. If a mixed configuration is encountered, the BIOS attempts to operate at the highest common frequency and the lowest latency possible.
  - x4 and x8 DDR4 DIMMs may be mixed in the same channel.
  - Mixing of DDR4 DIMM types (RDIMM, LRDIMM, 3DS-RDIMM, 3DS-LRDIMM) within or across processors is not supported. This is a Fatal Error Halt in Memory Initialization.
- For a single DDR4 DIMM in a dual-slot channel, populate slot 1 (blue slot).
- For multiple DDR4 DIMMs per channel:
  - When populating a quad-rank DIMM with a single- or dual-rank DDR4 DIMM in the same channel, the quad-rank DDR4 DIMM must be populated farthest from the processor. Incorrect DDR4 DIMM placement results in an MRC error code. A maximum of 8 logical ranks can be used on any one channel, as well as a maximum of 10 physical ranks loaded on a channel.
  - For RDIMM, LRDIMM, 3DS-RDIMM, and 3DS-LRDIMM, always populate DDR4 DIMMs with higher electrical loading in slot 1 (blue slot) followed by slot 2 (black slot).
- Memory slots associated with a given processor are unavailable if the corresponding processor socket is not populated.
- Processor sockets are self-contained and autonomous. However, all memory subsystem support (such as memory RAS and error management) in the BIOS Setup are applied commonly for each installed processor.
- For best system performance, memory must be installed in all eight channels for each installed processor.
- For best system performance in dual processor configurations, installed DDR4 DIMM type and population for DDR4 DIMMs configured to CPU 1 must match DDR4 DIMM type and population configured to CPU 0. For additional information, see [Section 4.3.3](#).

### 4.3.2 Intel® Optane™ Persistent Memory 200 Series Module Rules

All operating modes:

- Only Intel® Optane™ persistent memory 200 series modules are supported.
- Intel® Optane™ persistent memory 200 series modules of different capacities cannot be mixed within or across processor sockets.
- Memory slots supported by the Integrated Memory Controller 0 (IMC 0) (memory channels A and B) of a given processor must be populated before memory slots on other IMCs.
- For multiple DIMMs per channel:
  - Only one Intel® Optane™ persistent memory 200 series module is supported per memory channel.
  - Intel® Optane™ persistent memory 200 series modules are supported in either DIMM slot when mixed with LRDIMM or 3DS-LRDIMM.
  - Intel® Optane™ persistent memory 200 series modules are only supported in DIMM slot 2 (black slot) when mixed with RDIMM or 3DS-RDIMM.
- No support for SDRAM SRx8 DIMM that is populated within the same channel as the Intel® Optane™ persistent memory 200 series module in any operating mode.
- Ensure the same DDR4 DIMM type and capacity is used for each DDR4 + Intel® Optane™ persistent memory 200 series module combination.



## Memory mode:

- Populate each memory channel with at least one DDR4 DIMM to maximize bandwidth.
- Intel® Optane™ persistent memory 200 series modules must be populated symmetrically for each installed processor (corresponding slots populated on either side of each processor).

## App Direct mode:

- Minimum of one DDR4 DIMM per IMC (IMC 0, IMC 1, IMC 2 and IMC 3) for each installed processor.
- Minimum of one Intel® Optane™ persistent memory 200 series module for the board.
- Intel® Optane™ persistent memory 200 series modules must be populated symmetrically for each installed processor (corresponding slots populated on either side of each processor).

**Table 8. Intel® Optane™ Persistent Memory 200 Series Module Support**

Processor Shelf	Intel® Optane™ Persistent Memory 200 Series Capacity (GB)	Speed (MT/s)
Silver 4300 processors	128	2666
	256	2400
	512	
Gold 5300 processors	128	2933
	256	2666
	512	2400
Gold 6300 Processors	128	3200
	256	2933
	512	2666
		2400
Platinum 8300 processors	128	3200
	256	2933
	512	2666
		2400

**Table 9. Standard DDR4 DIMMs Compatible with Intel® Optane™ Persistent Memory 200 Series Module**

Type	Ranks per DIMM and Data Width	DIMM Size (GB)	
		8 Gb DRAM density	16 Gb DRAM density
RDIMM (PTH – up to 2933 MT/s) (SMT – up to 3200 MT/s)	SR x8	N/A	N/A
	SR x4	16	32
	DR x8	16	32
	DR x4	32	64
3DS-RDIMM (PTH – up to 2933 MT/s) (SMT – up to 3200 MT/s)	QR x4	N/A	128 (2H)
	OR x4	N/A	256 (4H)
LRDIMM (PTH/SMT – up to 3200 MT/s)	QR x4	64	128
3DS-LRDIMM (PTH/SMT – up to 3200 MT/s)	QR x4	N/A	N/A
	OR x4	128 (4H)	256 (4H)

**Note:** SR = Single Rank, DR = Dual Rank, QR = Quad Rank, OR = Oct Rank, H = Stack Height, PTH = Plated Through Hole, SMT = Surface-Mount Technology

### 4.3.3 Recommended Memory Configurations

This section provides the recommended memory population configurations for the Intel® Server System M50CYP1UR family system. For best system performance in dual-processor configurations, installed memory type and population should be the same for both processors.

The following figure identifies the memory slot locations and the following two tables provide recommended population configurations.

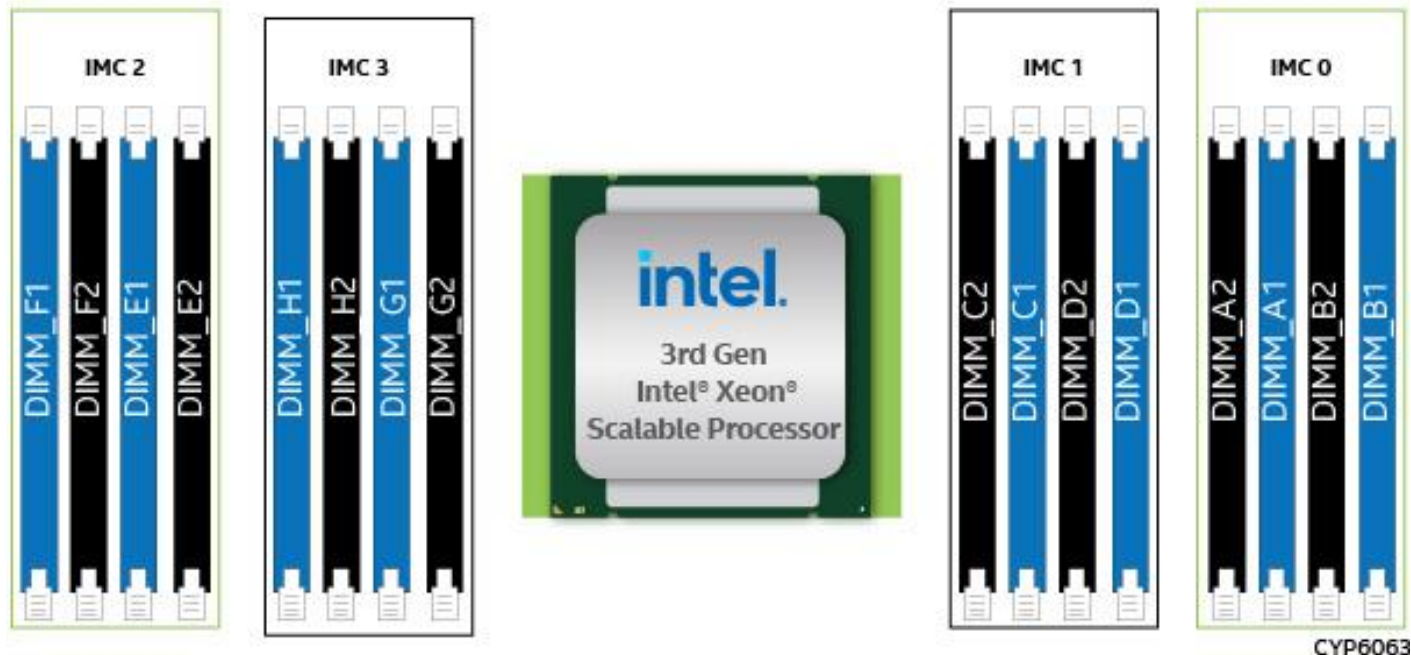

Figure 29. Memory Slot Identification

Table 10. Standard DDR4 DIMM-only per socket population configurations

# of DIMMs	IMC2				IMC3				IMC1				IMC0			
	CH F		CH E		CH H		CH G		CH C		CH D		CH A		CH B	
	Slot 1	Slot 2	Slot1	Slot2	Slot 1	Slot 2	Slot 1	Slot 2	Slot 2	Slot 1	Slot 2	Slot 1	Slot 2	Slot 1	Slot 2	Slot 1
1	-	-	-	-	-	-	-	-	-	-	-	-	-	DRAM	-	-
2	-	-	DRAM	-	-	-	-	-	-	-	-	-	-	DRAM	-	-
4	-	-	DRAM	-	-	-	DRAM	-	-	DRAM	-	-	-	DRAM	-	-
6	DRAM	-	DRAM	-	-	-	DRAM	-	-	DRAM	-	-	-	DRAM	-	DRAM
8	DRAM	-	DRAM	-	DRAM	-	DRAM	-	-	DRAM	-	DRAM	-	DRAM	-	DRAM
12	DRAM	DRAM	DRAM	DRAM	-	-	DRAM	DRAM	DRAM	DRAM	-	-	DRAM	DRAM	DRAM	DRAM
12	DRAM	-	DRAM	DRAM	DRAM	-	DRAM	DRAM	DRAM	DRAM	-	DRAM	DRAM	DRAM	-	DRAM
16	DRAM	DRAM	DRAM	DRAM	DRAM	DRAM	DRAM	DRAM	DRAM	DRAM	DRAM	DRAM	DRAM	DRAM	DRAM	DRAM

**Table 11. Standard DDR4 DIMM and Intel® Optane™ Persistent Memory 200 Series Module (PMem) Population Configurations**

DRAM / PMem	Mode	IMC2				IMC3				IMC1				IMC0			
		CH F		CH E		CH H		CH G		CH C		CH D		CH A		CH B	
		Slot 1	Slot 2	Slot 1	Slot 2	Slot 1	Slot 2	Slot 1	Slot 2	Slot 2	Slot 1	Slot 2	Slot 1	Slot 2	Slot 1	Slot 2	Slot 1
8 DRAM/ 8 PMem	AD or MM	DRAM	PMem	DRAM	PMem	DRAM	PMem	DRAM	PMem	PMem	DRAM	PMem	DRAM	PMem	DRAM	PMem	DRAM
8 DRAM/ 4 PMem	AD or MM	DRAM	-	DRAM	PMem	DRAM	-	DRAM	PMem	PMem	DRAM	-	DRAM	PMem	DRAM	-	DRAM
4 DRAM/ 4 PMem	AD or MM	PMem	-	DRAM	-	PMem	-	DRAM	-	-	DRAM	-	PMem	-	DRAM	-	PMem
		DRAM	-	PMem	-	DRAM	-	PMem	-	-	PMem	-	DRAM	-	PMem	-	DRAM
6 DRAM/ 1 PMem	AD	DRAM	-	DRAM	-	-	-	DRAM	-	-	DRAM	-	PMem	-	DRAM	-	DRAM
		-	-	DRAM	-	DRAM	-	DRAM	-	-	DRAM	-	DRAM	-	DRAM	-	PMem
		DRAM	-	DRAM	-	PMem	-	DRAM	-	-	DRAM	-	-	-	DRAM	-	DRAM
		PMem	-	DRAM	-	DRAM	-	DRAM	-	-	DRAM	-	DRAM	-	DRAM	-	-
8 DRAM/ 1 PMem	AD	DRAM	-	DRAM	-	DRAM	-	DRAM	-	-	DRAM	-	DRAM	PMem	DRAM	-	DRAM
		DRAM	-	DRAM	-	DRAM	-	DRAM	-	PMem	DRAM	-	DRAM	-	DRAM	-	DRAM
		DRAM	-	DRAM	PMem	DRAM	-	DRAM	-	-	DRAM	-	DRAM	-	DRAM	-	DRAM
		DRAM	-	DRAM	-	DRAM	-	DRAM	PMem	-	DRAM	-	DRAM	-	DRAM	-	DRAM
12 DRAM/ 2 PMem	AD	DRAM	DRAM	DRAM	DRAM	PMem	-	DRAM	DRAM	DRAM	DRAM	-	PMem	DRAM	DRAM	DRAM	DRAM
		DRAM	DRAM	DRAM	DRAM	PMem	-	DRAM	DRAM	DRAM	DRAM	-	PMem	DRAM	DRAM	DRAM	DRAM

**Note:** AD = App Direct mode, MM = Memory mode, PMem = Persistent Memory Module

Notes on Intel® Optane™ persistent memory 200 series module population:

- For MM, recommended ratio of standard DRAM capacity to Intel® Optane™ persistent memory 200 series module capacity is between 1 GB:4 GB and 1 GB:16 GB.
- For each individual population, rearrangements between channels are allowed as long as the resulting population is consistent with defined memory population rules.
- For each individual population, the same DDR4 DIMM must be used in all slots, as specified by the defined memory population rules.

## 4.4 Memory RAS Support

Processors within the 3<sup>rd</sup> Gen Intel® Xeon® Scalable processor family support the standard or advanced memory RAS features, depending on processor SKU, defined in Table 12. This table lists the RAS features pertaining to system memory that has standard DDR4 DIMMs or a combination of standard DDR4 DIMMS and Intel® Optane™ persistent memory 200 series modules. These features are managed by the processor's IMC.

**Table 12. Memory RAS Features**

Memory RAS Feature	Description	Standard	Advanced
<b>Partial Cache-Line Sprung (PCLS)</b>	Allows replacing failed single bit within a device using spare capacity available within the processor's integrated memory controller (IMC). Up to 16 failures allowed per memory channel and no more than one failure per cache line. After failure is detected, replacement is performed at a nibble level. Supported with x4 DIMMs only.	✓	✓
<b>Device Data Correction</b>	Single Device Data Correction (SDDC) via static virtual lockstep Supported with x4 DIMMs only.	✓	✓

Memory RAS Feature	Description	Standard	Advanced
	Adaptive Data Correction – Single Region (ADC-SR) via adaptive virtual lockstep (applicable to x4 DRAM DIMMs). Cannot be enabled with “Memory Multi-Rank Sparing” or “Write Data CRC Check and Retry.”	√	√
	Adaptive Double Data Correction – Multiple Region (ADDDC-MR, + 1) Supported with x4 DIMMs only.	–	√
<b>DDR4 Command/Address (CMD/ADDR) Parity Check and Retry</b>	DDR4 technology based CMD/ADDR parity check and retry with CMD/ADDR parity error “address” logging and CMD/ADDR retry.	√	√
<b>DDR4 Write Data CRC Check and Retry</b>	Checks for CRC mismatch and sends a signal back to the processor for retry. Cannot be enabled with “ADC-SR” or “ADDDC-MR, +1.”	√	√
<b>Memory Data Scrambling with Command and Address</b>	Scrambles the data with address and command in “write cycle” and unscrambles the data in “read cycle”. Addresses reliability by improving signal integrity at the physical layer. Additionally, assists with detection of an address bit error.	√	√
<b>Memory Demand and Patrol Scrubbing</b>	Demand scrubbing is the ability to write corrected data back to the memory once a correctable error is detected on a read transaction. Patrol scrubbing proactively searches the system memory, repairing correctable errors. Prevents accumulation of single-bit errors.	√	√
<b>Memory Mirroring</b>	Full memory mirroring: An intra-IMC method of keeping a duplicate (secondary or mirrored) copy of the contents of memory as a redundant backup for use if the primary memory fails. The mirrored copy of the memory is stored in memory of the same processor socket's IMC. Dynamic (without reboot) failover to the mirrored DIMMs is transparent to the operating system and applications.	√	√
	Address range/partial memory mirroring: Provides further intra socket granularity to mirroring of memory. It does this by allowing the firmware or operating system to determine a range of memory addresses to be mirrored, leaving the rest of the memory in the socket in non-mirror mode.	–	√
<b>DDR Memory Multi-Rank Memory Sparing</b>	Up to two ranks out of a maximum of eight ranks can be assigned as spare ranks. Cannot be enabled with “ADC-SR”, “ADDDC-MR, +1”, and “Memory Mirroring”.	√	√
<b>Memory SMBus* Hang Recovery</b>	Allows system recovery if the SMBus fails to respond during runtime, thus, preventing system crash.	√	√
<b>Memory Disable and Map Out for Fault Resilient Boot (FRB)</b>	Allows memory initialization and booting to OS even when memory fault occurs.	√	√
<b>Post Package Repair (PPR)</b>	PPR offers additional spare capacity within the DDR4 DRAM that can be used to replace faulty cell areas detected during system boot time.	√	√
<b>Memory Thermal Throttling</b>	Management controller monitors the memory DIMM temperature and can temporarily slow down the memory access rates to reduce the DIMM temperature if needed.	√	√
<b>MEMHOT Pin Support for Error Reporting</b>	MEMHOT pin can be configured as an output and can be used to notify if DIMM is operating within the target temperature range. Used to implement “Memory Thermal Throttling”.	√	√

**Notes:** Population Rules and BIOS Setup for Memory RAS

- Memory sparing and memory mirroring options are enabled in BIOS Setup.
- Memory sparing and memory mirroring options are mutually exclusive in this product. Only one operating mode at a time may be selected in BIOS Setup.

- If a RAS mode has been enabled and the memory configuration is not able to support it during boot, the system will fall back to independent channel mode and log and display errors.
- Rank sparing mode is only possible when all channels that are populated with memory have at least two single-rank or double-rank DIMMs installed, or at least one quad-rank DIMM installed, on each populated channel.
- Memory mirroring mode requires that for any channel pair that is populated with memory, the memory population on both channels of the pair must be identically sized.
- The Intel® Optane™ persistent memory 200 series RAS features listed in the following table are integrated into the system memory RAS features.

Table 13 lists additional memory RAS features specific to the Intel® Optane™ persistent memory 200 series memory. These features are managed by the processor's IMC.

**Table 13. Intel® Optane™ Persistent Memory 200 Series RAS Features**

Memory RAS Feature	Description
<b>DIMM Error Detection and Correction</b>	Protects against random bit failures across media devices.
<b>DIMM Device Failure Recovery (Single Device Data Correction (SDDC))</b>	Corrects errors resulting from the failure of a single media device.
<b>DIMM Package Sparing (Double Device Data Correction (DDDC))</b>	Achieved by a spare device on the DIMM and erasure decoding.
<b>DIMM Patrol Scrubbing</b>	Proactively searches the DIMM memory, repairing correctable errors. This action can prevent correctable errors from becoming uncorrectable due to accumulation of failed bits.
<b>DIMM Address Error Detection</b>	Ensures the correctness of addresses when data is read from media devices.
<b>DIMM Data Poisoning</b>	Mechanism to contain, and possibly recover from, uncorrectable data errors. Depending on the mode used, poisoning has different reset behavior: <ul style="list-style-type: none"> <li>• In Memory mode, poison is cleared after reset.</li> <li>• In App Direct mode, poison is not cleared with reset.</li> </ul>
<b>DIMM Viral</b>	Ensures that potentially corrupted data is not committed to persistent memory in App Direct and is supported only in tandem with poison. Viral mode does not apply to memory mode.
<b>DIMM Address Range Scrub (ARS)</b>	Obtains the healthy memory media range before assigning it to a persistent memory region.
<b>DDR-T Command and Address Parity Check and Retry</b>	Host retries a CMD/ADDR transaction if the DIMM controller detects a parity error and initiates an error flow.
<b>DDR-T Read Write Data ECC Check and Retry</b>	Host continuously retries a data transaction as long as the DIMM controller detects an ECC error and initiates an error flow.
<b>Faulty DIMM Isolation</b>	Identifies a specific failing DIMM enabling replacement of only the DIMM that has failed.

The Intel® Server System M50CYP family security feature support includes Intel® Software Guard Extensions (Intel® SGX), Intel® Total Memory Encryption (Intel® TME), and Intel® Total Memory Encryption – Multi-Tenant (Intel® TME-MT). When any of these security features are enabled, Intel® Optane™ PMem 200 Series will be disabled. In addition, some of the memory RAS features will be disabled as indicated in the following table.

**Table 14. Compatibility of RAS features Intel® SGX, Intel® TME, and Intel® TME-MT**

Feature/Technology	Intel® SGX	Intel® TME, Intel® TME-MT
Intel® Optane™ persistent memory 200 series	No	No
ADC(SR)/ADDDC(MR)	No	Yes
MCA Recovery – Execution Path	No	Yes
MCA Recovery – Non-execution Path	Yes	Yes
Address Range Mirroring	No	Yes
Dynamic Capacity change: CPU/Memory/IIO, Physical CPU Board Hot Add/Remove, OS CPU/Memory/IIO On-lining (Capacity change), OS CPU off-lining (Capacity change), Intel® UPI link Hot pluggability, and Intel® UPI System Quiescence.	No	Yes
Static/Hard Partitioning, Electronically Isolated (Static/Hard) Partitioning, Dynamic Partitioning (Via Resource/Capacity Addition), Multiple South Bridge (PCH) Presence for supporting system partitioning	No	Yes



## 5. System Power

The Intel® Server System M50CYP1UR family supports the following power supply options:

- AC 1300 W (80 PLUS\* Titanium)
- AC 1600 W (80 PLUS Titanium)

The server system supports up to two power supplies that are modular allowing for tool-less insertion and extraction from two rear facing externally accessible bays, one on each side of the chassis.

**Note:** In dual power supply configurations, both power supplies must be identical. Using two different power supply options concurrently is not supported. This invalid configuration will not provide power supply redundancy and will result in multiple errors being logged by the system.

**Note:** The power supply option(s) chosen depends on system configuration. See the *Intel® Server M50CYP Power Budget and Thermal Configuration Tool*, available as a download online at <https://downloadcenter.intel.com/>.

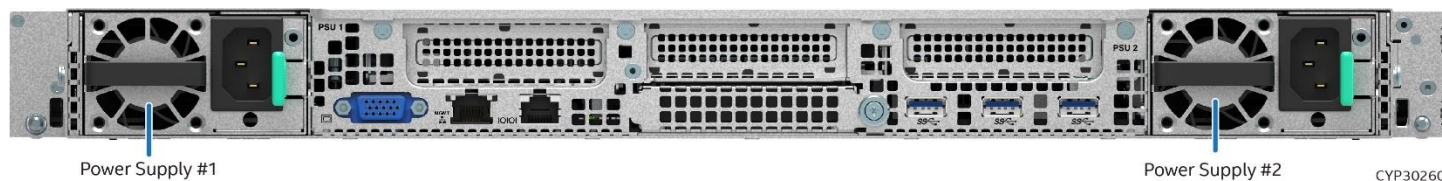

**Figure 30. Power Supply Module Identification**

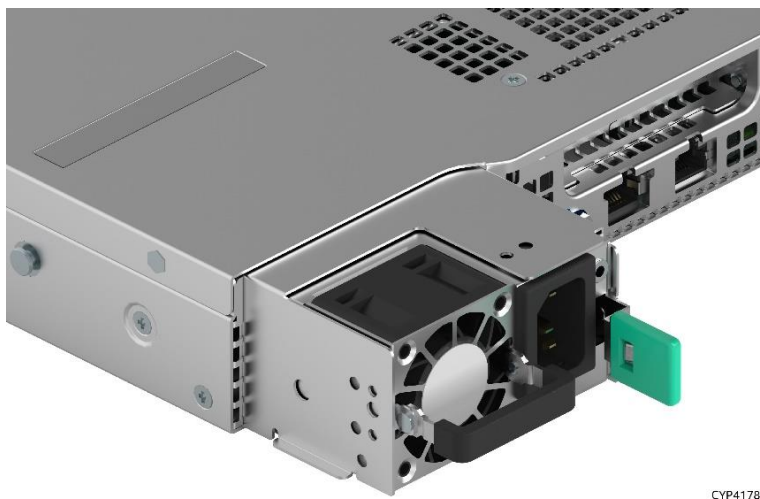

**Figure 31. Power Supply Module Partially Out of Chassis**



Figure 32. Power Supply Module

## 5.1 Power Supply Configurations

The system can support the following power configurations:

- **1+0** (One power supply – no redundancy)
- **1+1** (Two power supplies – redundant power)
- **2+0** (Two power supplies – combined power, no redundancy)

Embedded platform management will automatically determine and configure the power supply configuration. It does this based on the number of power supplies installed and the total power draw of the system. This automatic configuration may be overridden by customer configuration of BMC control structures.

### 5.1.1 Single Power Supply (1+0) Power Configuration

In a single power supply configuration, total available power to the system is limited to the maximum power capacity of the power supply. Anytime the system power draw exceeds the power limit of the power supply, server management will limit I/O operations, also referred to as “throttling”, to system memory, processors, or both, to try to reduce total system power draw. System performance will be degraded should throttling occur.

Single power supply configurations have no power redundancy. A power supply event that shuts down the power supply will shut off the server system.

### 5.1.2 Dual Power Supply 1+1 Power Configuration

In a dual power supply configuration, if the total power draw from the system is less than or equal to the maximum power capacity of a single power supply, platform management will automatically configure the system to support 1 + 1 redundant power. In a redundant power configuration, if one of the power supplies shuts down, the backup or secondary power supply will automatically engage and provide the necessary power to maintain optimal system operation.

---

**Note:** When platform management detects a power supply that has shut down, several system error and system status change events will be logged to the system event log. The System Status LED will change to Blinking Green, denoting a degraded but operational system state. In addition, system power will change to a non-redundant 1 + 0 configuration (see section above) until the failed power supply is replaced.

---

The power supplies are hot-swappable, allowing a failed power supply to be replaced without having to first power down the system. After replacing a failed power supply, platform management will automatically change the power configuration to either 1 + 1 or 2 + 0 depending on the total system power draw at the time the new power supply was detected.

### 5.1.3 Dual Power Supply 2+0 Power Configuration

In a dual power supply configuration, if the total power draw from the system is or becomes greater than the maximum power capacity of a single power supply, platform management will automatically configure the system to support a combined power (2 + 0) configuration. In this configuration, power from both power supplies will be used to supply the system with power to support optimal system operation.

In combined 2+0 power mode, total power available at peak power levels may be less than twice the rated power of the installed power supply modules. With the power supplies operating at peak levels, the amount of heat generated will prevent them from supplying maximum rated power.

If a power supply shuts down, platform management will limit system I/O operations, also referred to as “throttling”, to system memory, processors, or both. It does this action in an attempt to reduce the total system power draw to below the maximum power limit of a single power supply. System performance will be degraded should throttling occur.

---

**Note:** When platform management detects a power supply that has shut down, several system error and system status change events will be logged to the system event log. The System Status LED will change to Blinking Green, denoting a degraded but operational system state. In addition, system power will change to a non-redundant 1 + 0 configuration (see section above) until the failed power supply is replaced.

---

The power supplies are hot-swappable, allowing a failed power supply to be replaced without having to first power down the system. After replacing a failed power supply, platform management will automatically change the power configuration to either 1 + 1 or 2+ 0 depending on the total system power draw at the time the new power supply was detected.

## 5.2 Closed Loop System Throttling (CLST)

The Intel® Server System M50CYP1UR family supports Closed Loop System Throttling (CLST). CLST prevents the system from crashing if a power supply module is overloaded or overheats. If the system power reaches a pre-programmed power limit, CLST throttles system memory and/or processors to reduce power. System performance is degraded if this occurs.

## 5.3 Smart Ride Through (SmaRT) Throttling

The Intel® Server System M50CYP1UR family supports Smart Ride Through (SmaRT) throttling. This increases the reliability of a system operating in a heavy power load condition and to remain operational during an AC line dropout event.

When AC voltage is too low, a fast AC loss detection circuit inside each installed power supply asserts an SMBALERT# signal to initiate a throttle condition in the system. System throttling reduces the bandwidth to both system memory and processors that, in turn, reduces the power load during the AC line drop out event.

## 5.4 Power Supply Cold Redundancy

In dual power supply 1 + 1 redundant power configurations, by default the BMC enables support for Cold Redundancy mode. Cold redundancy can put the redundant power supply into a low power (almost off) standby state. This is done to save energy at system idle while still being able to turn back on fast enough (within 100 µsec) in case of a power supply failure to keep the system operating normally.

In cold redundancy mode, the BMC assigns and identifies each power supply as either “Active” or “Cold Stand-by”. The Active power supply provides the system with power. The Cold Stand-by power supply is placed in a low power standby state and is a backup to the Active power supply in case of failure.

To support highest long-term reliability of each power supply, the BMC schedules a rolling re-configuration. Installed power supplies alternate between being the “Active” and the “Cold Stand-by” that allows for equal loading over the lifetime of each power supply.

The BMC uses the `Cold_Redundancy_Config` command to both set each power supply’s role in cold redundancy and to enable/disable cold redundancy.

The following events trigger a reconfiguration of the power supplies using the `Cold_Redundancy_config` command:

- Source power ON
- PSON power ON
- Power supply failure
- Power supply inserted into system

## 5.5 Power Supply Specification Overview

The Intel® Server System M50CYP1UR family supports the following power supply options:

- AC 1300 W (80 PLUS Titanium)
- AC 1600 W (80 PLUS Titanium)

AC power supplies are auto-ranging and power factor corrected.

The following sections provide an overview of select power supply features and functions.

---

**Note:** Full power supply specification documents are available upon request. Power supply specification documents are classified as Intel Confidential and will require a signed NDA with Intel before being made available.

---

### 5.5.1 Power Supply Module Efficiency

Each power supply option is rated to meet specific power efficiency limits based on their 80 PLUS power efficiency rating: Titanium or Platinum.

The following tables define the required minimum power efficiency levels based on their 80 PLUS efficiency rating at specified power load conditions: 100%, 50%, 20%, and 10%.

The AC power supply efficiency is tested over an AC input voltage range of 115 VAC to 220 VAC.

**Table 15. 1300 W and 1600 W AC Power Supply Option Efficiency (80 PLUS\* Titanium)**

	Loading	100% of maximum	50% of maximum	20% of maximum	10% of maximum
	Minimum Efficiency	91%	96%	94%	90%

## 5.5.2 AC Power Cord Specifications



Figure 33. AC Power Cable Connector

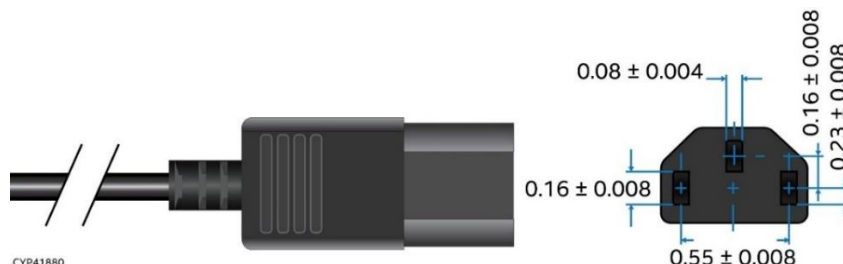

Figure 34. AC Power Cord Specification

The AC power cord used must meet the specification requirements listed in the following table.

Table 16. AC power Cord Specifications

Item	Description
Cable Type	SJT
Wire Size	14 AWG
Temperature Rating	105 °C
Amperage Rating	10 A at 240 V
Voltage Rating	240 VAC

## 5.6 AC Power Supply Features

The following sections describe features supported by the AC power supply options.

### 5.6.1 Power Supply Status LED

A single bi-color LED on the power supply indicates power supply status. The operational states of this bi-color LED are defined in the following table.

Table 17. LED Indicators

LED State	Power Supply Condition
Solid green	Output ON and OK.
Off	No source power to all power supplies.
1 Hz blinking green	Source power present/only 12 VSB on (PS off) or PS in cold redundant state.
Solid amber	Source power cord unplugged or source power lost; with a second power supply in parallel still with AC input power. Or power supply critical event causing a shutdown; failure, over current protection, over voltage protection, fan fail.
1 Hz blinking amber	Power supply warning events where the power supply continues to operate; high temp, high power, high current, slow fan.
2 Hz blinking green	Power supply firmware updating.

## 5.6.2 Protection Circuits

Each installed power supply module includes several protection circuits that will shut down the power supply in the event a defined operating threshold is exceeded.

### 5.6.2.1 Over Current Protection

Each installed power supply is protected against excess current. The power supply unit shuts down for a specific time period after crossing current thresholds. A power supply that is shut down due to an exceeded protection circuit threshold can be reset by removing source power for 15 seconds.

**Table 18. Over Current Protection, 1300 W and 1600 W Power Supply**

Output Voltage	Input Voltage Range	Over Current Limits	Over Current Protection Delay
+12 V	180–264 VAC	132 A minimum / 138 A maximum	50 msec minimum / 200 msec maximum
		152 A minimum / 160 A maximum	5 msec minimum / 20 msec maximum
	90–140 VAC	72 A minimum / 77 A maximum	50 msec minimum / 200 msec maximum
		103 A minimum / 107 A maximum	5 msec minimum / 20 msec maximum
12 VSB	90–264 VAC	2.5 A minimum / 3.5 A maximum	5 msec minimum / 20 msec maximum

**Table 19. Over Voltage Protection (OVP) Limits, 1300 W and 1600 W Power Supply**

Output Voltage	Minimum (V)	Maximum (V)
+12 V	13.5	14.5
+12 VSB	13.5	14.5

### 5.6.2.2 Over Temperature Protection (OTP)

Each installed power supply is protected against over temperature conditions caused by loss of fan cooling or excessive ambient temperature. The power supply unit shuts down during an OTP condition. Once the power supply temperature drops to within specified limits, the power supply restores power automatically.

---

**Note:** The 12 VSB always remains on while the power supply is connected to the power source.

---



## 6. Thermal Management

The fully integrated system is designed to operate at external ambient temperatures between 10–35 °C. Working with integrated platform management, several features are designed to move air from the front to the back of the system and over critical components to prevent them from overheating, allowing the system to operate optimally. The system supports fan redundancy to maintain system temperatures below maximum thermal limits should a fan failure occur. See [Appendix E](#) for thermal configuration limits for fan redundancy support.



**Figure 35. System Airflow and Fan Identification**

The following tables provide airflow data associated with the Intel® Server System M50CYP1UR family. This data is provided for reference purposes only. The data was derived from actual wind tunnel test methods and measurements using fully configured (worst case) system configurations. Different system configurations may produce slightly different data results. In addition, the cubic feet per minute (CFM) data provided using server management utilities that use platform sensor data may vary slightly from the data listed in the tables.

**Table 20. System Volumetric Airflow – M50CYP1UR204**

System Fan	Power Supply Fan	Total Airflow (CFM)
100%	Auto	138.0
100%	100%	139.0
55%	Auto	60.0

**Table 21. System Volumetric Airflow – M50CYP1UR212**

System Fan	Power Supply Fan	Total Airflow (CFM)
100%	Auto	114
100%	100%	116
55%	Auto	55

Several system components are installed and configured to maintain system thermal characteristics. They include:

- Eight managed 40 mm system fans
- Fans integrated into each installed power supply module
- Air duct
- Populated drive carriers
- Installed DIMMs and DIMM blanks
- Installed processor heat sinks

Front drive bays must be populated with either an SSD or supplied drive blank.

In addition, it is necessary to have all black DIMM slots populated with either DIMMs or supplied DIMM blanks. All system configurations ship from Intel with DIMM blanks pre-installed. Pre-installed DIMM blanks should only be removed when installing a memory module in its place.

## 6.1 Thermal Operation and Configuration Requirements

To keep the system operating within supported thermal limits, the system must meet the following operating and configuration guidelines:

- The system is designed to sustain operations at an ambient temperature of up to 35 °C (ASHRAE Class A2) with short term excursion based operation up to 45 °C (ASHRAE Class A4).
- The system is designed to support long term reliability targets when operated at an external ambient temperature of up to 35 °C (ASHRAE A2). See [Table 3](#) for extended temperature support details.
- The system can operate up to 40 °C (ASHRAE Class A3) for up to 900 hours per year.
- The system can operate up to 45 °C (ASHRAE Class A4) for up to 90 hours per year.
- System performance may be impacted when operating within the extended operating temperature range.
- There is no long term system reliability impact when operating at the extended temperature range within the documented limits.
- System performance may be impacted when operating within the extended operating temperature range.

Specific configuration requirements and limitations are documented in [Appendix E](#). This information is also in the *Intel® Server M50CYP Power Budget and Thermal Configuration Tool*, available as a download online at <https://downloadcenter.intel.com/>.

The CPU 0 processor and heat sink must be installed first. In single processor configurations, the processor and heat sink must be installed into the CPU 0 processor socket. A single processor configuration where the processor is installed into the CPU 1 processor socket is not supported.

Thermally, a system supporting fan redundancy supports the following PCIe\* add-in cards when the system is operating at up to a maximum operating ambient temperature of 35 °C (ASHRAE Class 2).

Airflow for add-in cards is measured at the local inlet. Add-in card thermal support limits are listed per riser and riser slot in the following tables. This limitation is driven primarily by fan failure performance.

**Table 22. PCIe\* add-in Card Airflow (LFM) Support Limits – M50CYP1UR204, M50CYP1UR212 Fan Normal**

Slot	Riser Slot #1	PCI* Interposer Riser Slot	Riser Slot #2
PCIe* Add-In Slot	300	300	300

**Table 23. PCIe\* add-in Card Airflow (LFM) Support Limits – M50CYP1UR204, M50CYP1UR212 Fan Failure**

Slot	Riser Slot #1	PCI* Interposer Riser Slot	Riser Slot #2
PCIe* Add-In Slot	300	300	300

**Note:** Most PCIe\* add-in cards have cooling requirements of airflow up to 100 LFM (0.5 m/s), while some of the more difficult to cool cards have airflow requirements of up to 200 LFM (1 m/s).

System thermal requirements dictate that a specific airflow must be maintained over or between critical system components. To ensure proper airflow, all black DIMM slots must be populated with a DIMM or factory installed DIMM blank while the system is operating. The following figure identifies the memory slots that must be populated in all 1U system configurations. For information on memory population rules, see [Section 4.3](#).

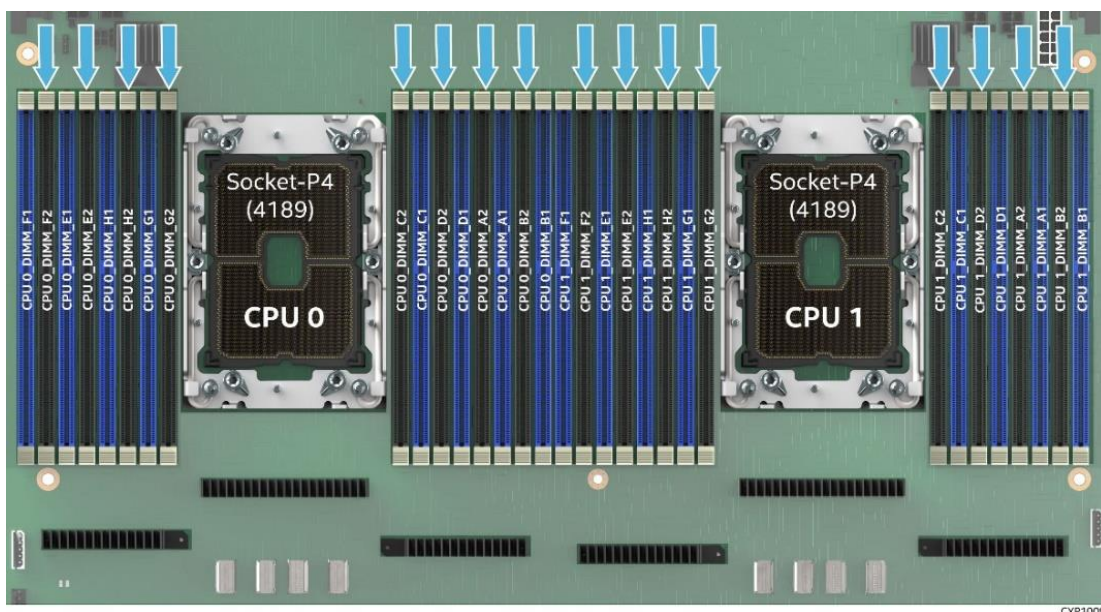
**Figure 36. System DIMM/DIMM Blanks Configuration**

**Note:** To maintain system thermals while the system is operational, black DIMM slots identified with  must be populated with a DIMM or supplied DIMM blank.

## 6.2 Thermal Management Overview

To maintain the necessary airflow within the system, all previously listed components and top cover need to be properly installed. For optimal system performance, the external ambient temperature should remain below 35 °C and all system fans should be operational.

The system is designed for fan redundancy when configured with two power supply modules. That is, all system fan rotors are operational and ambient air remains at or below ASHRAE class 2 limits. System fan rotor redundancy can be supported with limited performance for some components in the system. Refer to [Appendix E](#) for performance in fan failed mode.

Each system fan has two rotors. Should a single system fan rotor fail, platform management will adjust airflow of the remaining system fans and manage other platform features to maintain system thermals. Fan redundancy is lost if more than one fan rotor in the same fan or different fans are in a failed state.

For system configurations that support fan redundancy, if a single fan rotor failure occurs (system fan or power supply fan), integrated platform management does the following:

- Changes the state of the system status LED to blinking green,
- Reports an error to the system event log, and
- Automatically adjusts fan speeds of operational fans as needed to maintain system temperatures below maximum thermal limits.

---

**Note:** All system fans are controlled independently of each other. The fan control system may adjust fan speeds for different fans based on increasing/decreasing temperatures in different thermal zones within the chassis.

---

If system temperatures continue to increase with the system fans operating at their maximum speed, platform management may begin to throttle bandwidth of either the memory subsystem, the processors, or both. It does this action to keep components from overheating and keep the system operational. Throttling of these subsystems continues until system temperatures are reduced below preprogrammed limits.

The power supply is protected against over temperature conditions caused by excessive ambient temperature. If such condition occurs, the power supply module will shut down to protect itself from overheating.

If system thermals increase to a point beyond the maximum thermal limits, the system shuts down, the system status LED changes to solid amber, and the event is logged to the system event log. If power supply thermals increase to a point beyond their maximum thermal limits or if a power supply fan should fail, the power supply shuts down.

---

**Note:** For proper system thermal management, sensor data records (SDRs) for any given system configuration must be loaded by the system integrator as part of the initial system integration process. SDRs are loaded using the FRUSDR utility. This utility is part of the system update package (SUP) or System Firmware Update Package (SFUP) utility that can be downloaded from <http://downloadcenter.intel.com>.

---

## 6.3 System Fans

Eight 40 x 40 x 38 mm system fans and an embedded fan for each installed power supply module provide the primary airflow for the system.

Each individual fan:

- Is hot-swappable.
- Is blind-mated to a matching 8-pin connector behind the fan slot on the server board.
- Is designed for tool-less insertion and extraction from the fan assembly.
- Has a tachometer signal that allows the integrated BMC to monitor its status.
- Has its fan speed controlled by integrated platform management. As system thermals fluctuate high and low, the integrated BMC firmware increases and decreases the speeds to specific fans within the fan assembly to regulate system thermals.

---

**Note:** For further information on fan speed control, see [Section 6.5](#).

---

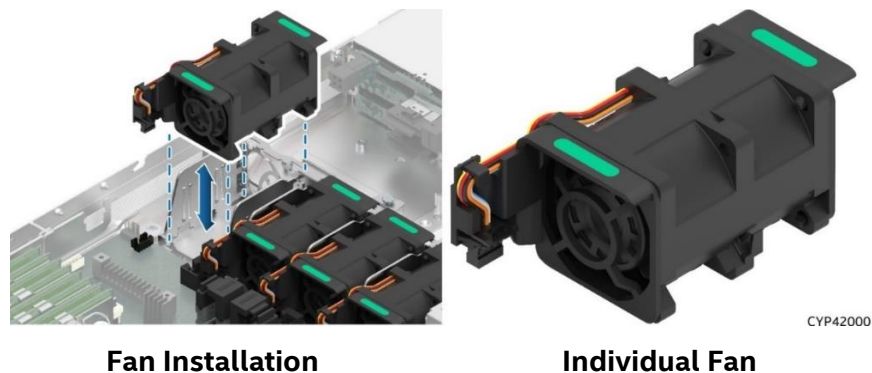

Figure 37. System Fan Assembly

## 6.4 Power Supply Module Fans

Each installed power supply module includes embedded (non-removable) 38-mm fans. These fans are responsible for airflow through the power supply module and are managed by the fan control system. If a fan fails, the power supply shuts down.

## 6.5 Fan Speed Control

The BMC controls and monitors system fans. Each fan is associated with a fan speed sensor that detects fan failure and may also be associated with a fan presence sensor for hot-swap support. For redundant fan configurations, the fan failure and presence status determines the fan redundancy sensor state.

The system fans are divided into fan domains, each of which has a separate fan speed control signal and a separate configurable fan control policy. A fan domain can have a set of temperature and fan sensors associated with it. The sensors are used to determine the current fan domain state.

A fan domain has three states: sleep, boost, and nominal. The sleep and boost states have fixed (but configurable through OEM SDRs) fan speeds associated with them. The nominal state has a variable speed determined by the fan domain policy. An OEM SDR record is used to configure the fan domain policy.

The fan domain state is controlled by several factors, listed below in order of precedence from high to low. If any of these conditions apply, the fans are set to a fixed boost state speed.

- An associated fan is in a critical state or missing. The SDR describes which fan domains are boosted in response to a fan failure or removal in each domain. If a fan is removed when the system is in fans-off mode, it is not detected and there is not any fan boost until the system comes out of fans-off mode.
- Any associated temperature sensor is in a critical state. The SDR describes which temperature-threshold violations cause fan boost for each fan domain.
- The BMC is in firmware update mode, or the operational firmware is corrupted.
- If any of the above conditions apply, the fans are set to a fixed boost state speed.

For more information on nominal fan speed, see [Section 6.5.5](#).

### 6.5.1 Programmable Fan Pulse Width Modulation (PWM) Offset

The system provides a BIOS Setup option to boost the system fan speed by a programmable positive offset setting. Enabling the **Fan PWM Offset** option causes the BMC to add the offset to the fan speeds to which it would otherwise be driving the fans. This setting causes the BMC to replace the domain minimum speed with alternate domain minimums that are also programmable through SDRs.

This capability is offered to provide system administrators the option to manually configure fan speeds in instances where the fan speed optimized for a given platform may not be sufficient when a high-end add-in adapter is configured into the system. This capability enables easier usage of the fan speed control to support Intel and non-Intel chassis and better support of ambient temperatures higher than 35 °C.



## 6.5.2 Hot-Swappable Fans

Hot-swap fans are supported and can be removed and replaced while the system is powered on and operating. The BMC implements fan presence sensors (sensor type = Fan (04h), event / reading type = Generic (08h) for each hot-swappable fan.

When a fan is not present, the associated fan speed sensor is put into the reading/unavailable state and any associated fan domains are put into the boost state. The fans may already be boosted due to a previous fan failure or fan removal.

When a removed fan is inserted, the associated fan speed sensor is re-armed. If there are no other critical conditions causing a fan boost condition, the fan speed returns to the nominal state. Power cycling or resetting the system re-arms the fan speed sensors and clears fan failure conditions. If the failure condition is still present, the fan returns to its boosted state once the sensor has re-initialized and the threshold violation is detected again.

## 6.5.3 Fan Redundancy Detection

The BMC supports redundant fan monitoring and implements a fan redundancy sensor. A fan redundancy sensor generates events when the associated set of fans transitions between redundant and non-redundant states as determined by the number and health of the fans.

---

**Note:** The definition of fan redundancy is server system configuration dependent as the BMC allows for redundancy to be configured on a per-fan redundancy sensor basis through OEM SDR records.

---

A fan failure or removal of hot-swap fans up to the number of redundant fans specified in the SDR in a fan configuration is a non-critical failure and is reflected in the front panel status. A fan failure or removal that exceeds the number of redundant fans is a non-fatal, insufficient-resources condition, and is reflected in the front panel status as a non-fatal error. In the front control panel, a blinking green system status LED indicates non-critical error and a blinking amber LED indicates non-fatal error.

Redundancy is checked only when the system is in the DC-On state. Fan redundancy changes occurring when the system is DC-off or when AC is removed will not be logged until the system is turned on.

## 6.5.4 Fan Domains

System fan speeds are controlled through Pulse Width Modulation (PWM) signals that are driven separately for each domain by integrated PWM hardware. Fan speed is changed by adjusting the duty cycle that is the percentage of time the signal is driven high in each pulse.

The BMC controls the average duty cycle of each PWM signal through direct manipulation of the integrated PWM control registers.

The same device may drive multiple PWM signals.

## 6.5.5 Nominal Fan Speed

A fan domain's nominal fan speed can be configured statically (fixed value) or controlled by the state of one or more associated temperature sensors.

OEM SDR records are used to configure which temperature sensors are associated with which fan control domains and the algorithmic relationship between the temperature and fan speed. Multiple OEM SDRs can reference or control the same fan control domain and multiple OEM SDRs can reference the same temperature sensors.

Hysteresis can be specified to minimize fan speed oscillation and to smooth fan speed transitions. If a Tcontrol SDR record does not contain a hysteresis definition (for example, an SDR adhering to a legacy format), the BMC assumes a hysteresis value of zero.



## 6.5.6 Thermal and Acoustic Management

This feature allows for enhanced fan management to keep the system optimally cooled while reducing the amount of noise generated by the system fans. Aggressive acoustics standards might require a trade-off between fan speed and system performance parameters that contribute to the cooling requirements, primarily memory bandwidth. The BIOS, BMC, and SDRs work together to provide control over how this trade-off is determined.

This capability requires the BMC to access temperature sensors on individual memory DIMMs. Additionally, closed-loop thermal throttling is only supported with DIMMs containing temperature sensors.

## 6.5.7 Thermal Sensor Input to Fan Speed Control

The BMC uses various IPMI sensors as input to the fan speed control. Some of the sensors are IPMI models of actual physical sensors, whereas some are “virtual” sensors whose values are derived from physical sensors using calculations and/or tabular information.

The following IPMI thermal sensors are used as input to fan speed control:

- Front panel temperature sensor <sup>1</sup>
- Processor margin sensors <sup>2, 4, 5</sup>
- DIMM thermal margin sensors <sup>2, 4</sup>
- Exit air temperature sensor <sup>1, 7, 9</sup>
- PCH temperature sensor <sup>3, 5</sup>
- Add-in SAS module temperature sensors <sup>3, 5</sup>
- Power Supply Unit (PSU) thermal sensor <sup>3, 8</sup>
- Processor VR temperature sensors <sup>3, 6</sup>
- DIMM VR temperature sensors <sup>3, 6</sup>
- BMC temperature sensor <sup>3, 6</sup>
- Global aggregate thermal margin sensors <sup>7</sup>
- Hot swap backplane temperature sensors
- Intel® Ethernet Network Adapter for OCP\* adapter temperature sensor (with option installed)
- Riser card temperature sensors

---

### Notes:

<sup>1</sup> For fan speed control in Intel chassis

<sup>2</sup> Temperature margin to maximum junction temp

<sup>3</sup> Absolute temperature

<sup>4</sup> PECl value or margin value

<sup>5</sup> On-die sensor

<sup>6</sup> Server board sensor

<sup>7</sup> Virtual sensor

<sup>8</sup> Available only when PSU has PMBus\*

<sup>9</sup> Calculated estimate

---

The following figure shows a high-level representation of the fan speed control structure that determines fan speed.

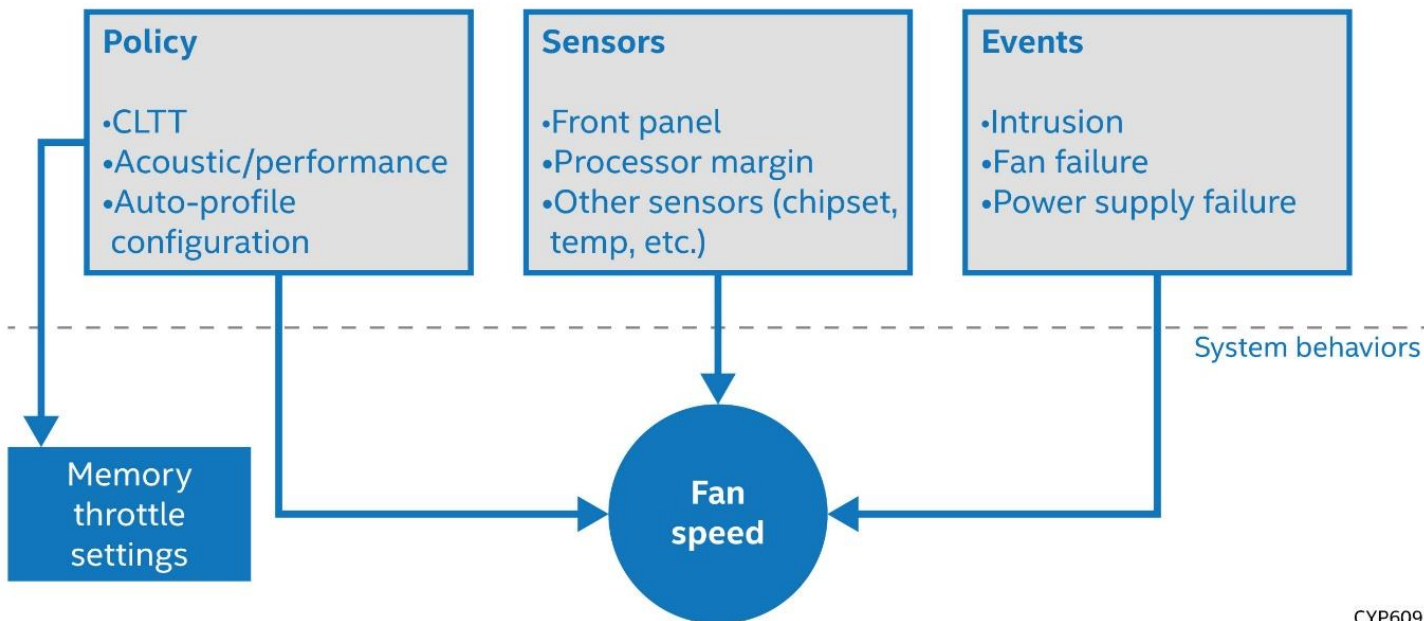

CYP6091

Figure 38. High Level Fan Speed Control Structure

## 6.6 FRUSDR Utility

The purpose of the embedded platform management and fan control systems is to monitor and control various system features and to maintain an efficient operating environment. Platform management is also used to communicate system health to supported platform management software and support mechanisms. The FRUSDR utility is used to program the server board with platform specific environmental limits, configuration data, and the appropriate sensor data records (SDRs) for use by these management features.

As part of the system manufacturing process, a default software stack is loaded that contains FRU and SDR data. However, this software may not be the latest available version. Intel recommends updating the SDR to the latest available as part of a planned system software update.

The FRUSDR utility for the given server platform can be downloaded as part of the System Update Package (SUP) or System Firmware Update Package (SFUP) from <http://downloadcenter.intel.com>.

---

**Note:** The embedded platform management system may not operate as expected if the platform is not updated with accurate system configuration data. The FRUSDR utility must be run with the system fully configured during the initial system integration process for accurate system monitoring and event reporting.

---

## 7. PCIe\* Add-in Card Support

This chapter provides information on the Intel® Server System M50CYP1UR family's PCI Express\* (PCIe\*) add-in card support. The PCIe\* add-in card slots are fully compliant with the *PCIe Express Base Specification, Revision 4.0* supporting the following PCIe\* bit rates: 4.0 (16 GT/s), 3.0 (8.0 GT/s), 2.0 (5.0 GT/s), and 1.0 (2.5 GT/s).

The server system supports a variety of riser card options for add-in card support as well as to enhance the base feature set of the system. These riser cards are available as accessory options for the server system. The system provides concurrent support for up to four PCIe riser cards, including one PCIe\* Interposer riser card and up two NVMe\* riser cards.

Through a combination of riser cards, the system supports the following:

- Concurrent support for up to three add-in cards
- Up to four front drive bay NVMe\* SSDs through NVMe\* riser cards

The server system supports several types of Intel® Ethernet Network Adapters. The Intel OCP\* network adapters are unique. They adhere to the OCP\* specification and have a special connector that allows them to be installed in the OCP\* mezzanine slot on the server board. These adapters are compatible with the Open Compute Project\* (OCP\*) 3.0 Specification.

The following figures show the add-in card areas in the back bay of the server system.

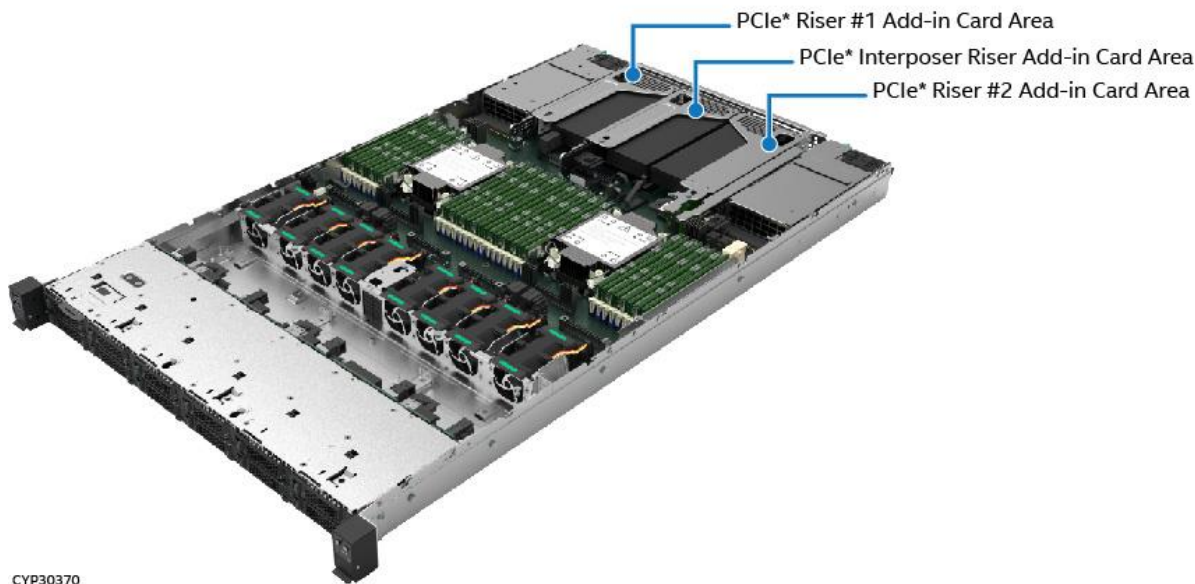

**Figure 39. Server System PCIe\* Riser Add-in Card Areas**

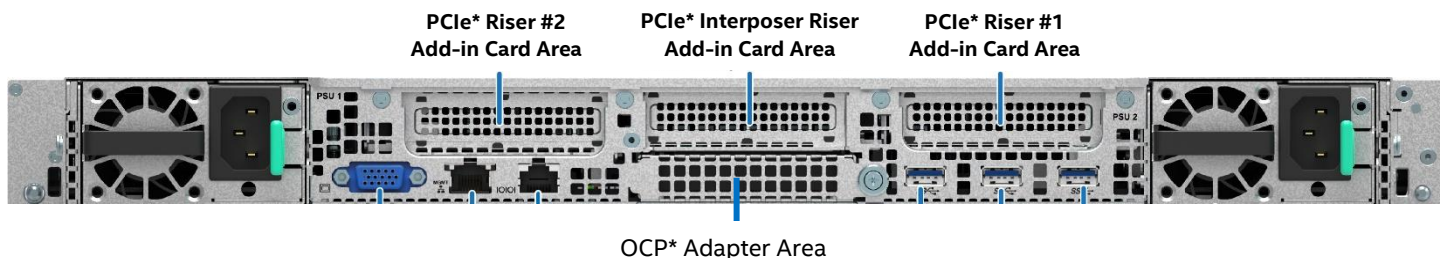

**Figure 40. Server System Back Bay Add-in Card Areas**

The following sections provide details on PCIe\* riser card support, Riser card assemblies, and OCP\* adapters.

## 7.1 PCIe\* Riser Card Support

The server system supports riser cards through riser slots identified as Riser Slot #1, Riser Slot #2, Riser Slot #3, and PCI\* Interposer Riser Slot. The PCIe\* data lanes for Riser Slot #1 are supported by CPU 0. The PCIe\* data lanes for Riser Slot #2, Riser Slot #3, and PCI\* Interposer Riser Slot are supported by CPU 1. A dual processor configuration is required when using Riser Slot #2, Riser Slot #3, or PCI\* Interposer Riser Slot.

The following table provides the processor/chipset port routing for PCIe-based server board connectors including OCP\* connector, PCIe\* SlimSAS\* connectors, and riser card slots. This chapter discusses the Riser card support and OCP\* adapter support. The M.2 connectors are discussed in [Chapter 8](#).

**Table 24. Processor / Chipset PCIe\* Port Routing**

Host	Port	Width	Gen.	Usage
CPU 0	Port 0A–0D	x16	4.0	OCP* Adapter Mezzanine connector
	Port 1A–1D	x16	4.0	Riser Slot #1 [15:0]
	Port 2A–2D	x16	4.0	Riser Slot #1 [31:16]
	Port 3A–3D	x16	4.0	Server board PCIe* SlimSAS connectors
	DMI3	x4	3.0	Chipset (PCH)
CPU 1	Port 0A–0D	x16	4.0	Riser Slot #3 [15:0]
	Port 1A–1D	x16	4.0	Riser Slot #2 [31:16]
	Port 2A–2D	x16	4.0	Riser Slot #2 [15:0]
	Port 3A–3D	x16	4.0	Server board PCIe* SlimSAS connectors
Chipset (PCH)	Port 4–7	x4	3.0	M.2 Connector- SATA / PCIe*
	Port 8–11	x4	4.0	M.2 Connector- SATA / PCIe*

---

**Note:** The riser card slots are specifically designed to support riser cards only. Attempting to install a PCIe\* add-in card directly into a riser card slot on the server board may damage the server board, the add-in card, or both.

**Note:** Riser Slot #3 does not support add-in cards.

**Note:** Different system configurations within the 1U family have different PCIe\* add-in card population requirements based on supported airflow limits. System integrators should identify PCIe\* add-in card airflow requirements from vendor specifications when integrating any add-in card into the system to ensure the chosen PCIe\* add-in card slot can meet the card's airflow requirements.

---

The following figure shows the add-in card orientation when installed in the system.

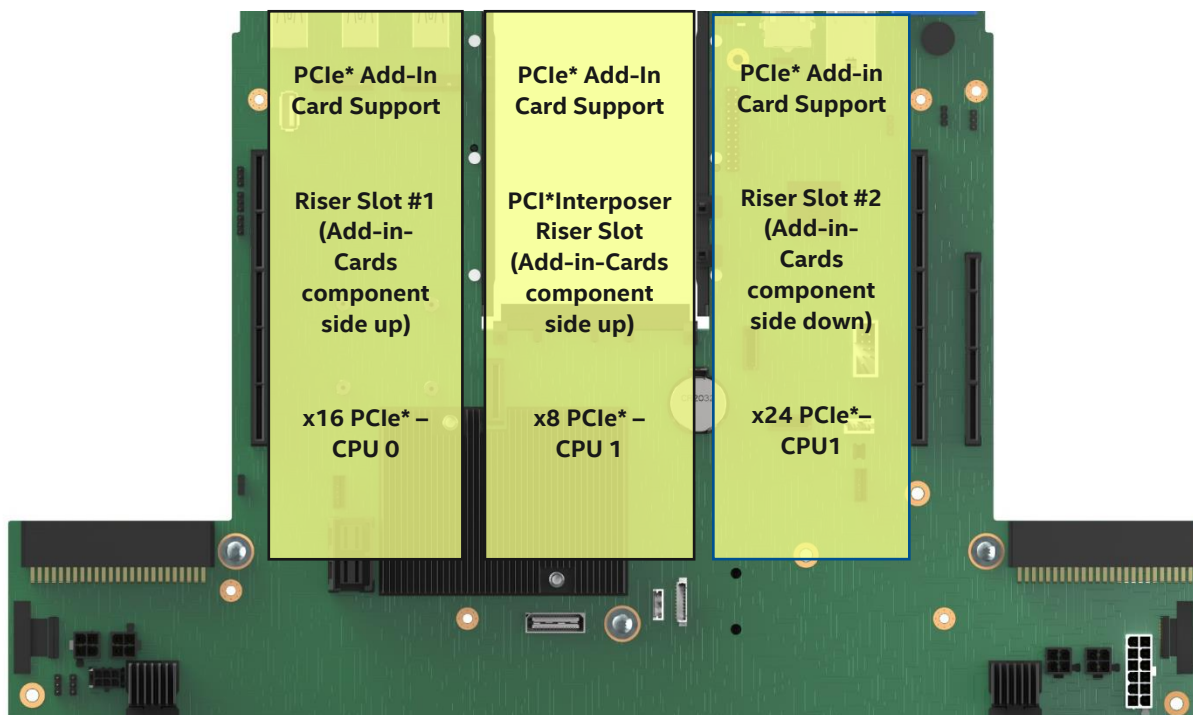

**Figure 41. PCIe\* add-in Card Orientation**

### 7.1.1 PCI Express Bifurcation

The Intel® Server System M50CYP1UR family supports the following PCIe\* bifurcation:

- Add-in card slot on 1-Slot PCIe\* riser card (iPC – CYP1URISER1STD) for Riser Slot #1: x16/x8x8/x8x4x4/x4x4x8/x4x4x4x4
- Add-in card slot on 1-Slot PCIe\* riser card (iPC – CYP1URISER2STD) for Riser Slot #2: x16/x8x8/x8x4x4/x4x4x8/x4x4x4x4
- Add-in card slot on 2-Slot PCIe\* Riser Card (iPC – CYP1URISER2KIT) for Riser Slot #2: x16/x8x8/x8x4x4/x4x4x8/x4x4x4x4

---

**Note:** In any riser card option, each PCIe\* add-in card slot is connected to clock signals. When a PCIe\* add-in card slot is configured with any of the available bifurcation options in the BIOS, the slot provides clock signals to only one of the bifurcated PCIe data lane groups. The add-in card must provide clock signals to the remaining PCIe data lane groups.

---

To change the PCIe\* bifurcation setting, access the BIOS Setup menu by pressing <F2> key during POST. Navigate to the following menu: **Advanced > Integrated IO Configuration > PCIe Slot Bifurcation Setting**

## 7.2 Riser Card Assembly

The add-in cards must be installed in the server system through riser card assemblies. Each riser card assembly has three components as shown in the following figure: riser card, riser bracket, and filler panel. The add-in card is mounted to the riser card. The riser card is mounted to the bracket that is inserted into the appropriate riser card / PCIe\* Interposer Riser Slot on the server board.

---

**Note:** Different system configurations in this server system family have different PCIe\* add-in card population requirements based on supported airflow limits. See [Section 6.1](#) for more information. System integrators should identify PCIe\* add-in card airflow requirements from vendor specifications when integrating any add-in card into the system. Ensure the chosen PCIe\* add-in card slot can meet the card's airflow requirements.

---

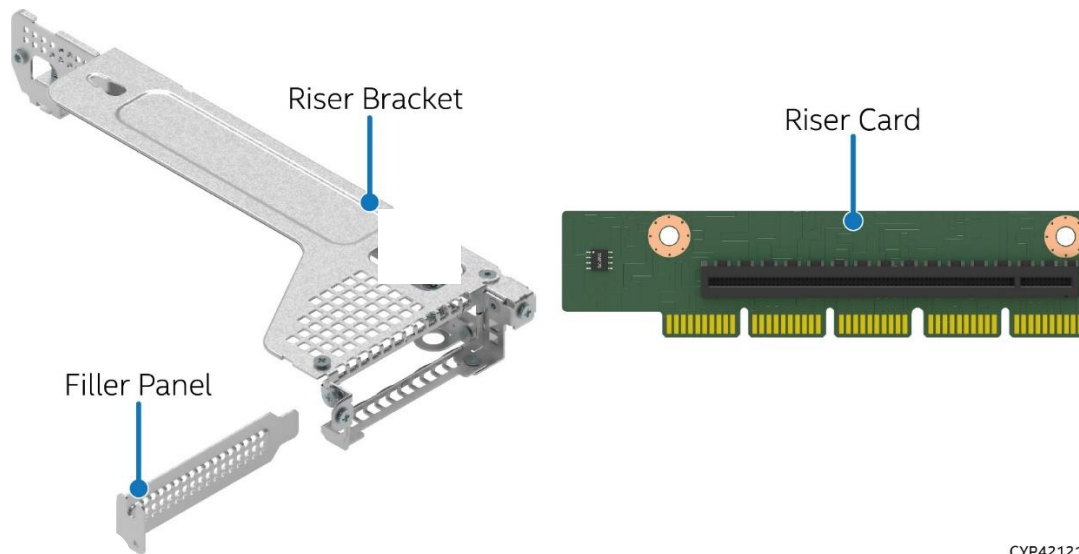

CYP42121

**Figure 42. Riser Bracket Components**

Installation of each riser card assembly into the chassis is tool-less. Notches on the back edge of the riser card assembly are aligned with slots on the chassis. Then, each assembly is pushed down into the respective riser card slots on the server board as shown in the following figure.



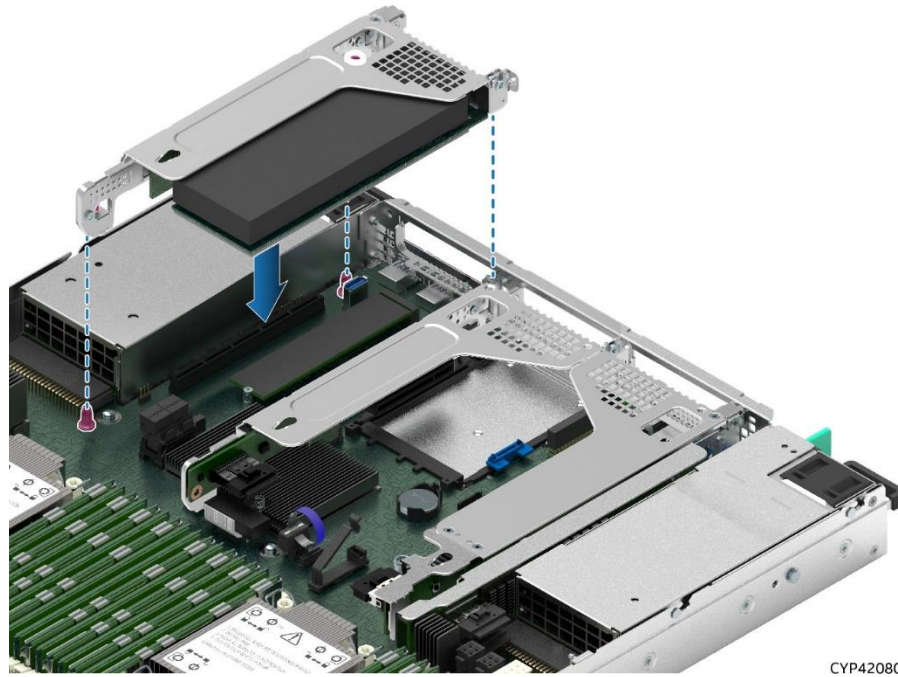

CYP42080

**Figure 43. Add-in Card Placement into Server System Chassis**

Depending on the system configuration, the server system may or may not come pre-configured with riser card options installed. All system configurations include the mounting brackets for each supported riser card option. The following figures show the riser card brackets for each server board riser slot and the interposer bracket.

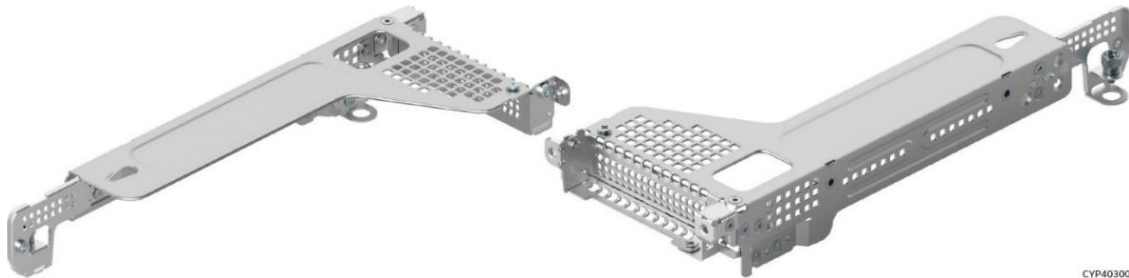

CYP40300

**Figure 44. Bracket for Riser Card on Riser Slot #1– Two Views**

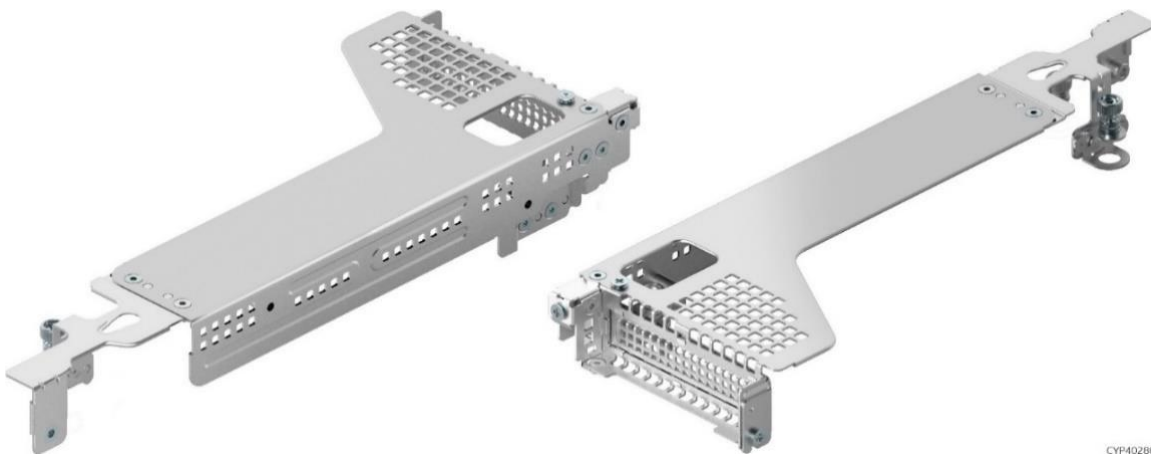

CYP40280

**Figure 45. Bracket for Riser Card on Riser Slot #2– Two Views**



**Figure 46. Bracket for Riser Card on Riser Slot #3– Two Views (NVMe\* Support Only)**

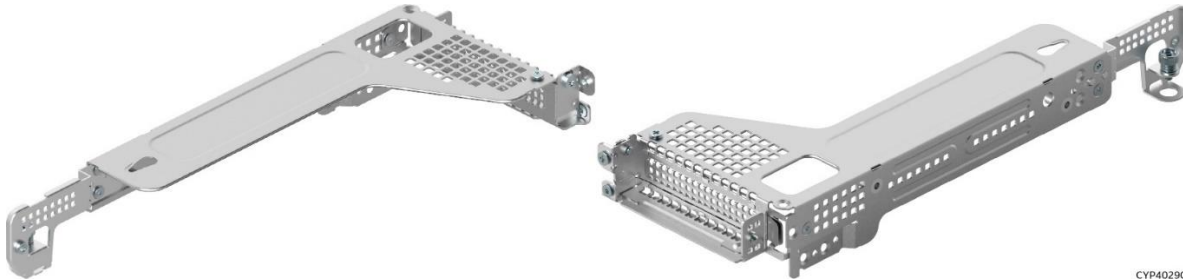

**Figure 47. Bracket for PCIe\* Interposer Riser Card – Two Views**

### 7.3 PCIe\* Riser Card and Interposer Card Options

The following sections provide details on the riser card and Interposer card accessory options.

#### 7.3.1 PCIe\* Riser Card for Riser Slot #1 (iPC – CYP1URISER1STD)

The One-Slot PCIe\* riser card, shown in the following figure, supports one low profile, half length, single-width add-in card. The add-in card connected to this riser card must be oriented with component side up.

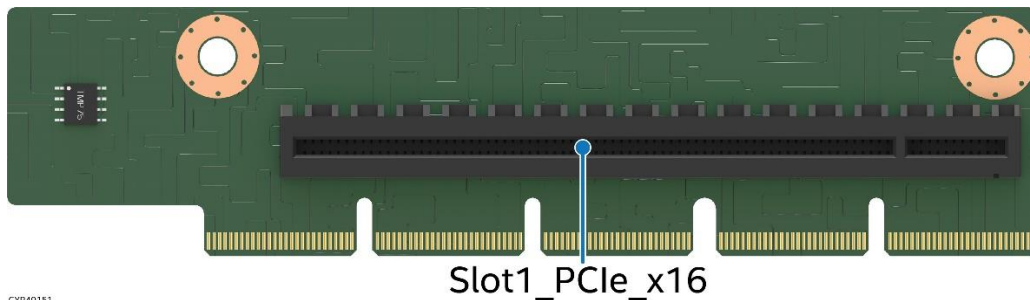

**Figure 48. PCIe\* Riser Card for Riser Slot #1**

**Table 25. PCIe\* Riser Card Connector Description**

Connectors	Description	Maximum Power Available (W)
Slot1_PCl_e_x16	CPU 0 – Ports 2A through 2D (x16 electrical, x16 mechanical)	75

### 7.3.2 PCIe\* Riser Card for Riser Slot #2 (iPC – CYP1URISER2STD)

The One-Slot PCIe\* riser card, shown in the following figure, supports one low profile, half length, single-width add-in card. The add-in card connected to this riser card must be oriented with component side down.

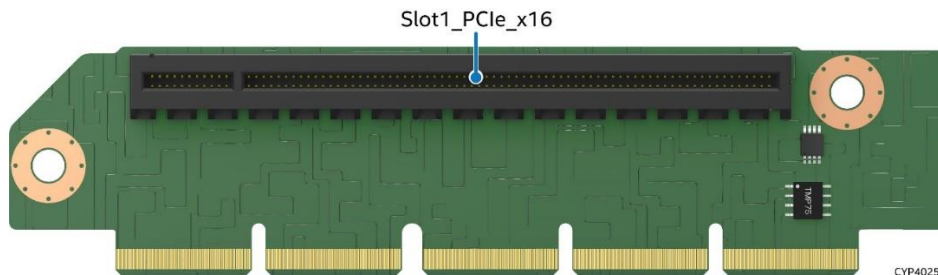

Figure 49. PCIe\* Riser Card for Riser Slot #2

Table 26. PCIe\* Riser Card Connector Description

Connector	Description	Maximum Power Available (W)
Slot1_PCl_e_x16	CPU 1 – Ports 1A through 1D (x16 electrical, x16 mechanical)	75

### 7.3.3 PCIe\* NVMe\* Riser Card for Riser Slot #2 (iPC – CYP1URISER2KIT)

The PCIe\* NVMe\* riser card, shown in the following figure, has two connectors. The connector labeled “Slot1\_PCl\_e\_x16” supports one low profile half length, single-width add-in card. The add-in card connected to this riser card must be oriented with component side down.

The x8 PCIe\* SlimSAS\* connector is used to provide PCIe\* data lanes to the PCIe\* interposer riser card. See Section 7.3.4 for more information. This connector does not support connection to the NVMe drives in the front drive bay.

The Intel accessory kit (iPC – CYP1URISER2KIT) includes the PCIe\* interposer riser card, PCIe\* NVMe\* riser card, and PCIe\* interposer cable.



Figure 50. PCIe\* NVMe\* Riser Card for Riser Slot #2

Table 27. PCIe\* NVMe\* Riser Card Connector Description

Connector	Description	Maximum Power Available (W)
Slot1_PCl_e_x16	CPU 1 – Ports 2A through 2D (x16 electrical, x16 mechanical)	75
PCl_e_SSD_0-1	CPU 1 – Ports 1A through 1B (x8 electrical, x8 mechanical)	N/A

### 7.3.4 PCIe\* Interposer Card (iPC – CYP1URISER2KIT)

The PCIe\* Interposer Riser Slot and PCIe\* interposer riser card were designed to provide additional add-in card support for the server system. The PCIe\* interposer riser card shown in the following figure is an accessory option supported by the PCIe\* Interposer Riser Slot.

This card has one PCIe\* add-in card slot (x8 electrical, x8 mechanical) labeled “Slot1\_PCl\_e\_x8” that supports one low profile, half length, single-width add-in card.

This card also has one x8 PCIe\* NVMe\* SlimSAS\* connector labeled “Slot1\_PCl\_e\_AIC\_Interposer”. The Interposer card’s functionality depends on the PCIe\* NVMe\* riser card in Riser Slot #2. The x8 PCIe\* data lanes used by the PCIe\* add-in card slot are routed by an interface cable from Intel PCIe\* NVMe\* riser card (accessory option) plugged into Riser Slot #2. To use the interposer card, the PCIe\* NVMe\* SlimSAS connector on the PCIe\* interposer riser card must be connected to the PCIe\* NVMe\* SlimSAS connector (PCIe\_SSD\_0-1) on the NVMe\* riser card using the PCIe\* interposer cable as shown in Figure 52.

---

**Note:** The SlimSAS connector on the Interposer card must only be used to connect to the NVMe riser card in Riser Slot #2.

---

The Intel accessory kit CYP1URISER2KIT includes:

- PCIe\* interposer riser card
- PCIe\* NVMe\* riser card
- PCIe\* interposer cable

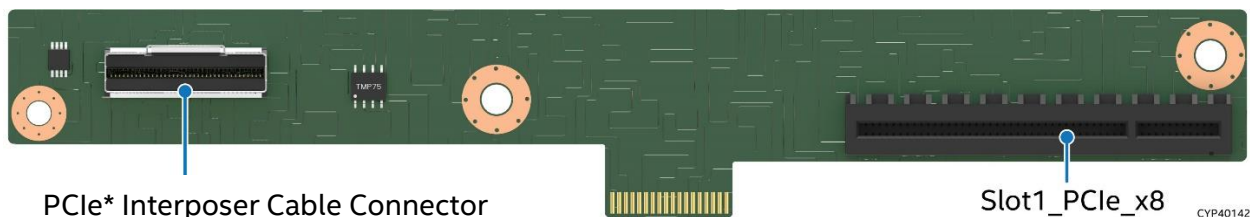

Figure 51. PCIe\* Interposer Riser Card

Table 28. PCIe\* Interposer Riser Card Connector Description

Connector	Description	Maximum Power Available (W)
Slot1_PCl_e_x8	CPU 1 – Ports 1A through 1B (x8 electrical, x8 mechanical)	25
PCIe* Interposer Cable Connector	CPU 1 – Ports 1A through 1B (x8 electrical, x8 mechanical)	N/A

---

**Note:** The PCIe Interposer cable must not be completely inserted into the cable clip to ensure the cable does not pull on the riser cards. Place the cable at the mouth of the clip as shown in the following figure.

---

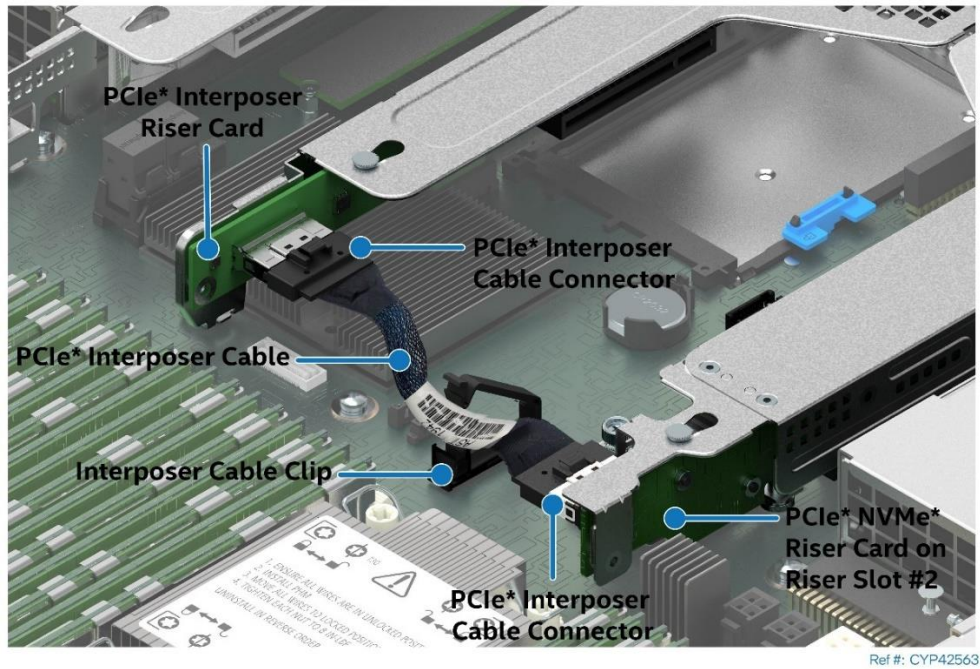

Figure 52. PCIe\* Interposer Riser Card to PCIe\* NVMe\* Riser Card Connectivity

Table 29. PCIe\* Interposer Riser Slot Pinout

Pin #	PCIe* Signal (from processor perspective)	Pin #	PCIe* Signal (from processor perspective)
A1	GND	B1	GND
A2	Spare	B2	Spare
A3	Spare	B3	Spare
A4	GND	B4	GND
A5	12V	B5	12V
A6	12V	B6	12V
A7	GND	B7	GND
A8	12V	B8	12V
A9	12V	B9	12V
A10	GND	B10	GND
A11	3.3VAUX	B11	Spare
A12	3.3V PWRGD	B12	Spare
A13	GND	B13	GND
A14	SMBus Clock	B14	Spare
A15	SMBus Data	B15	Spare
A16	GND	B16	GND
A17	FRU/Temp ADDR [I]	B17	PERST_N
A18	PWRBRK_N	B18	PE_WAKE_N
A19	GND	B19	GND
A20	REFCLK_TOP_P	B20	Riser ID[0]



Pin #	PCIe* Signal (from processor perspective)	Pin #	PCIe* Signal (from processor perspective)
A21	REFCLK_TOP_N	B21	Riser ID[1]
A22	GND	B22	GND
A23	Spare	B23	SYS_THROTTLE_N
A24	Spare	B24	MUX_RST_N
A25	GND	B25	GND
A26	Spare	B26	Spare
A27	Spare	B27	Spare
A28	GND	B28	GND

## 7.4 Intel® Ethernet Network Adapter for OCP\* Support

The server system supports several types of Intel® Ethernet Network Adapters. They adhere to the OCP\* specification and have a special connector that allows them to be installed to the OCP slot on the server board. These adapters are compatible with the Open Compute Project\* (OCP\*) 3.0 Specification.

**Note:** Only the Ethernet Network Adapters for OCP listed in the following table are supported.

**Table 30. Supported Intel® Ethernet Network Adapters for OCP\***

Description	Interface	iPC
Dual port, RJ45, 10/1 GbE	PCI* 3.0	X710T2LOCPV3
Quad port, SFP+ DA, 4x 10 GbE	PCI* 3.0	X710DA4OCPV3
Dual Port, QSFP28 100/50/25/10 GbE	PCI* 4.0	E810CQDA2OCPV3
Dual Port, SFP28 25/10 GbE	PCI* 4.0	E810XXVDA2OCPV3

The OCP-compatible adapters are mounted to a high density 168-pin mezzanine connector on the server board labeled “OCP\_IO\_Module”. The following figure shows the OCP\* adapter placement on the server board.

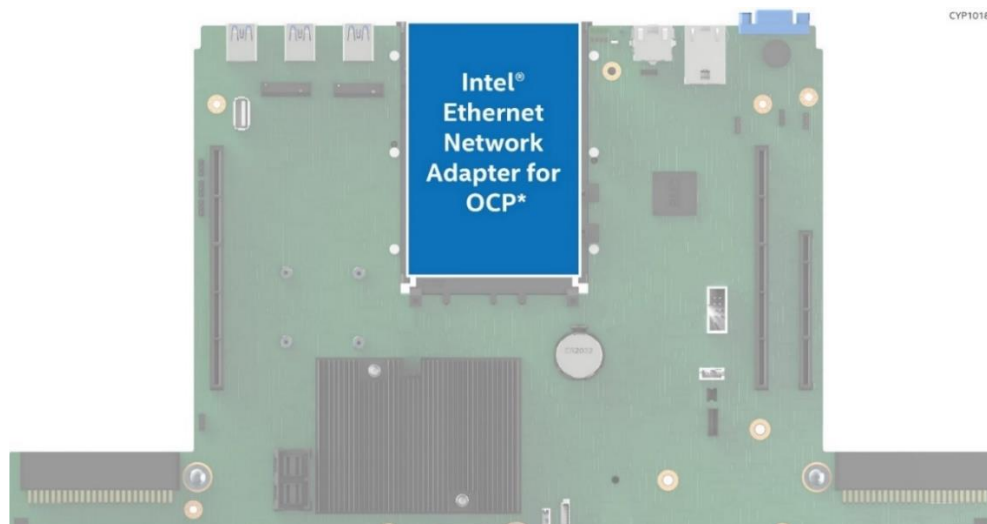

**Figure 53. Intel® Ethernet Network Adapter for OCP\* Placement**



OCP adapters supported by the Intel Server System M50CYP1UR family are installed into an OCP bay in the back of the chassis. The adapters are installed from the outside of the chassis. First remove the bay filler panel (see Figure 54). Then, carefully slide the adapter into the bay until it is fully seated in the OCP slot on the server board and is locked in place (see Figure 55). For more information on OCP\* adapter installation and removal of each OCP\* module type, see the *Intel® Server System M50CYP1UR Family System Integration and Service Guide*.

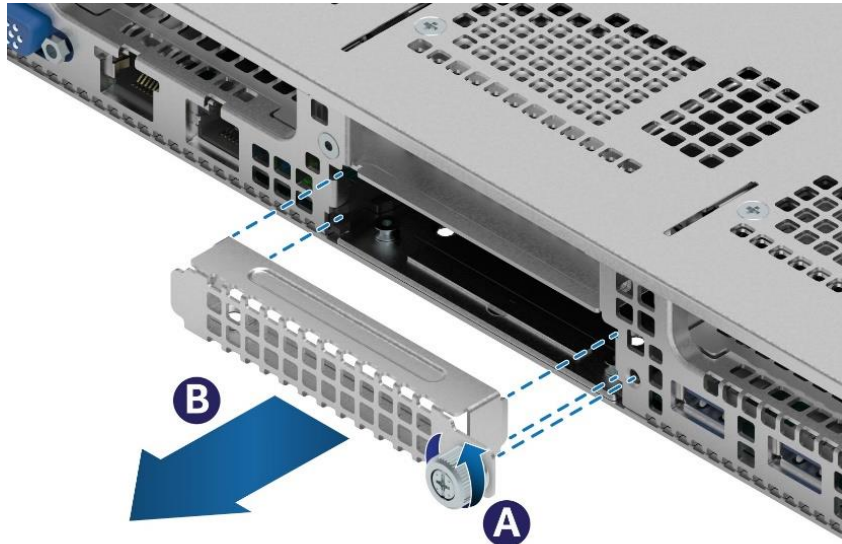

CYP40860

**Figure 54. OCP\* Adapter Bay Filler Removal**



CYP40850

**Figure 55. OCP\* Adapter with Pull Tab Installation**

## 8. System Storage

The Intel® Server System M50CYP1UR family provides various storage options including Non-Volatile Memory Express (NVMe\*) storage options. NVMe\* is an optimized, high-performance scalable storage interface designed to address the needs of enterprise systems that use PCIe\*-based solid-state storage, providing efficient access to non-volatile memory storage devices. The NVMe\* technology allows Intel server systems to take advantage of the levels of parallelism possible in modern SSDs.

The server system provides various hot swap backplane options for flexible front drive bay connectivity. The server system also provides various SAS and SATA storage options described in this chapter.

The Intel® Server System M50CYP1UR family supports the following storage options:

- System configurations supporting up to 4 or up to 12 front mount hot swap 2.5" SAS/SATA/NVMe\* SSD drives (support for both 7 mm and 15 mm height)
- Up to two server board mounted M.2 PCIe\*/SATA SSDs

Additional Intel® VROC NVMe\* and Intel® VROC SATA capabilities are available. The Intel® Server System M50CYP1UR family supports Intel® VROC 7.5.

---

**Note:** The rules and operations for Intel® VROC NVMe\* and Intel® VROC SATA are different from previous generation server systems. The rules and operations are discussed in this chapter.

---

Support for different storage options varies depending on the configuration and/or available accessory options installed. This chapter provides an overview of each available option.

### 8.1 Front Drive Bay Support

The Intel® Server System M50CYP1UR family supports the following front drive bay options:

- Up to 4 or up to 12 front mount hot swap 2.5" SAS/SATA/NVMe\* SSD drives (support for both 7 mm and 15 mm height)

The following figures illustrate the front drive bay options.

---

**Note:** Drive numbering in the system illustrations is for general reference only. Actual drive numbering is dependent on SAS/SATA controller configuration and how they are cabled to the backplane. On the backside of each installed backplane, there is a multiport Mini-SAS HD data connector for each set of four SATA/SAS drives. The backplane supports PCIe\* NVMe\* drives and includes a single PCIe\* SlimSAS\* connector for each NVMe\* drive supported on the backplane.

---



**Figure 56. 4 x 2.5" Front Drive Bay Configuration – M50CYP1UR204**



**Figure 57. 12 x 2.5" Front Drive Bay Configuration – M50CYP1UR212**

### 8.1.1 Hot Swap Drives and Drive Mounting Rail Support

Each SAS/SATA/NVMe\* drive interfaces with a backplane through a tool-less 2.5" hot-swap drive mounting rail. Drive mounting rails include a latching mechanism used to assist with drive extraction and insertion as shown in the following figure. The figure shows a 7 mm height drive. A drive can be inserted into the drive mounting rail only after combining it with a drive blank top.

**Note:** For more information on installation / removal of 7 mm drives, refer to the *Intel® Server System M50CYP1UR Family System Integration and Service Guide*.

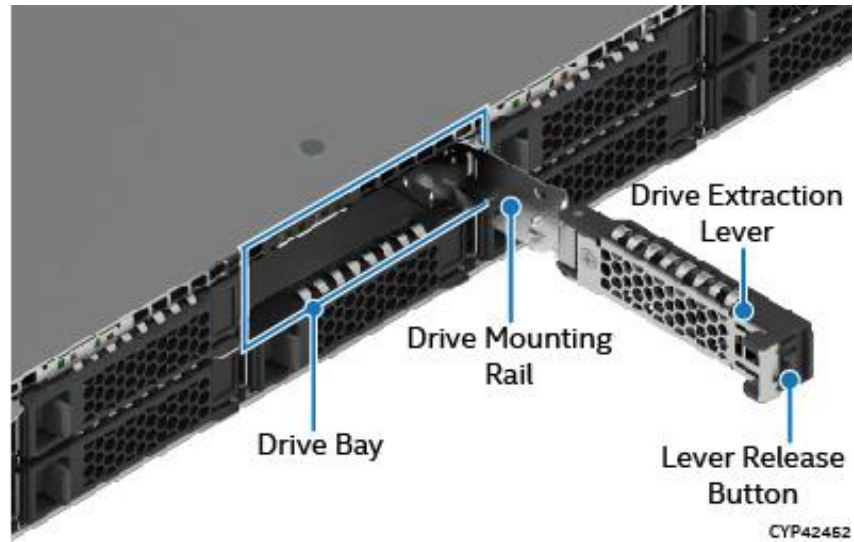

Figure 58. 2.5" Drive Bay Components

**Note:** The drive mounting rail does not detach from the chassis when pulled from the drive bay. The drive extraction lever will stop when it reaches its travel limit. Do not attempt to detach the drive mounting rail from the chassis. Doing so may damage the drive mounting rail making it unusable.

#### 8.1.1.1 2.5" Drive Blank Support

To ensure proper system airflow requirements, all front drive bays must be populated with either a drive or supplied drive blank.

Each drive carrier includes a 2.5" drive blank assembly. This assembly consists of two parts, top and bottom as shown in the following figure.

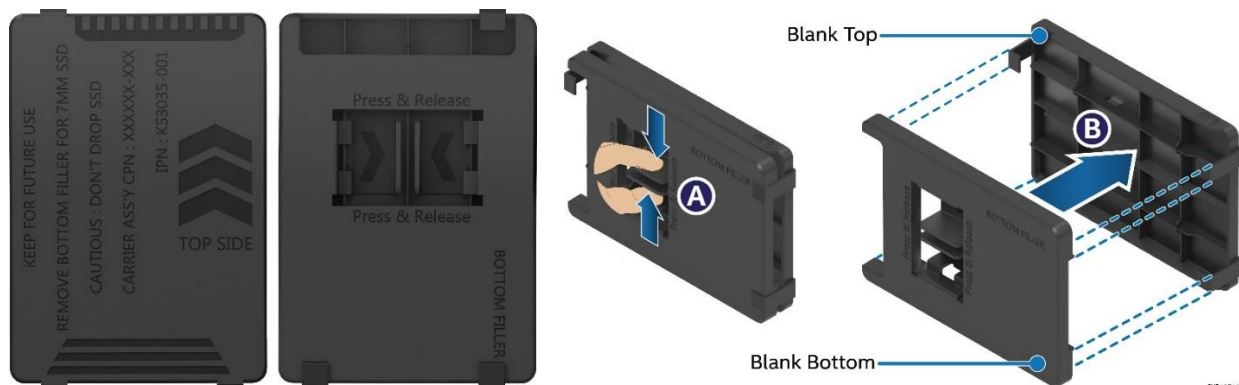

Figure 59. 2.5" Hot-Swap Drive Blank Top / Bottom and Attaching the Two

A 7 mm height drive can be inserted into the drive carrier using the top part of the blank as shown in the following figure. A drive blank is not needed to insert a 15 mm height drive into the drive carrier.

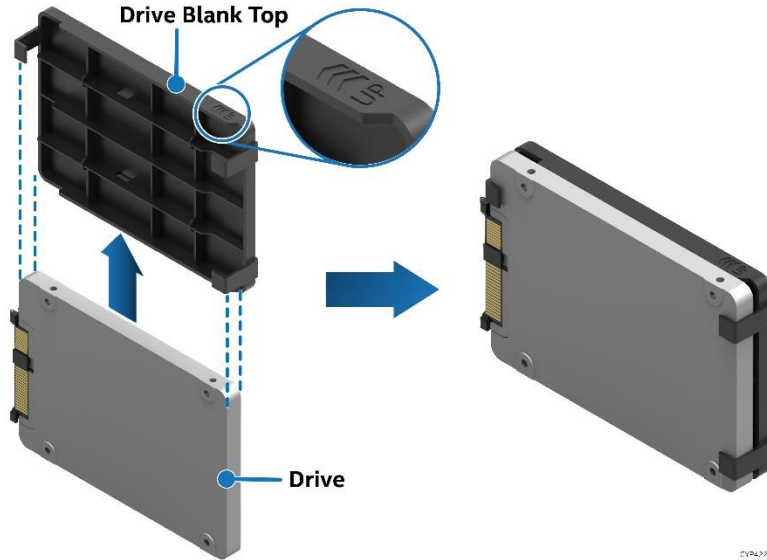

Figure 60. 2.5" 7 mm Height Drive Assembly with Drive Blank

### 8.1.1.2 7 mm Drive Insertion and Removal

A 7 mm drive can be inserted into the drive bay only after combining it with a drive blank top. The following figures show the 7 mm SSD being installed in the drive bay and removed from the drive bay.

---

**Note:** For more information on installation / removal of 7 mm drives, refer to the *Intel® Server System M50CYP1UR Family System Integration and Service Guide*.

---

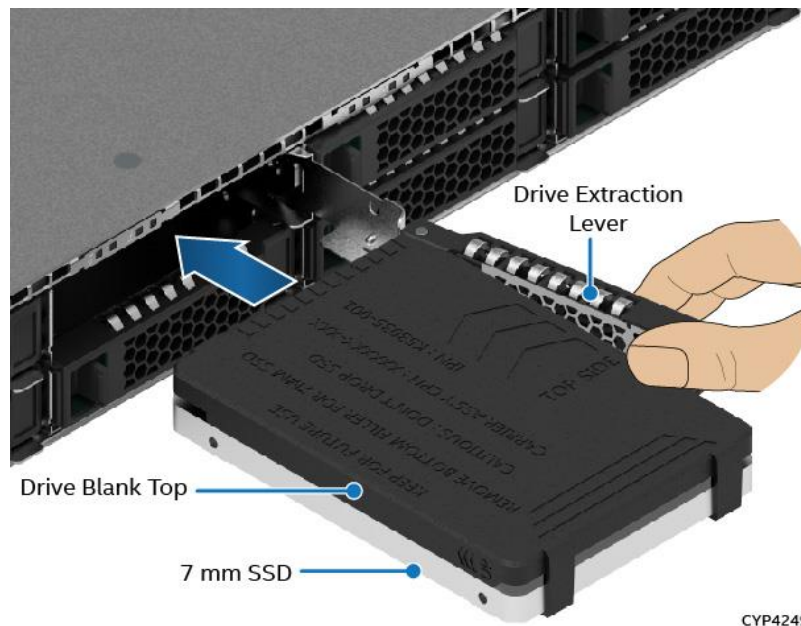

Figure 61. 2.5" 7 mm Drive Outside Chassis, Ready for Installation



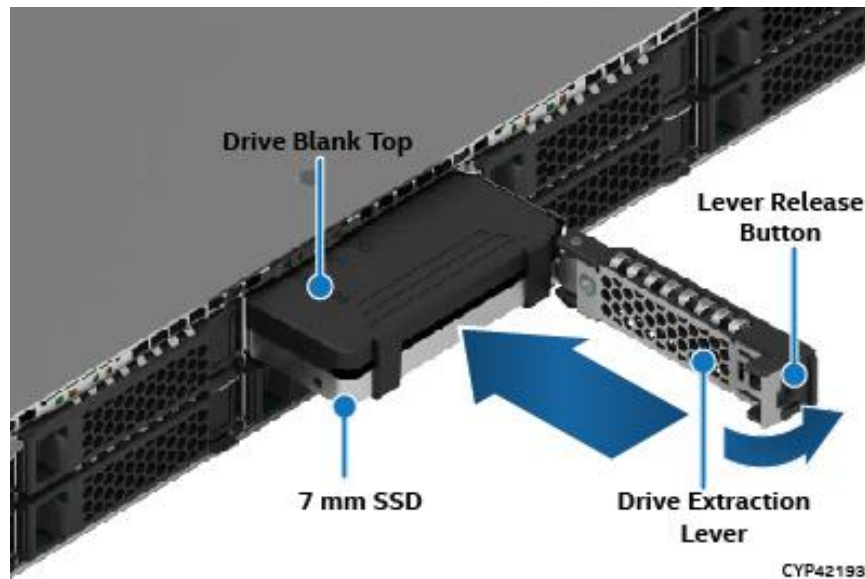

Figure 62. 7 mm Drive Installation into 2.5" Drive Bay



Figure 63. 7 mm Drive Removal from 2.5" Drive Bay

### 8.1.1.3 15 mm Drive Insertion and Removal

A 15 mm height drive does not need a drive blank. The following figures show a 15 mm drive being installed into the drive bay and removed from the drive bay.

---

**Note:** For more information on installation / removal of 15 mm drives, refer to the *Intel® Server System M50CYP1UR Family System Integration and Service Guide*.

---

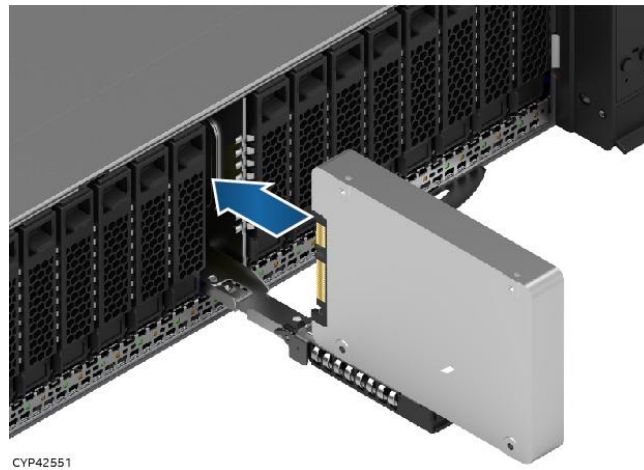

CYP42551

Figure 64. 15 mm Drive Insertion into 2.5" Drive Bay, Ready to Install

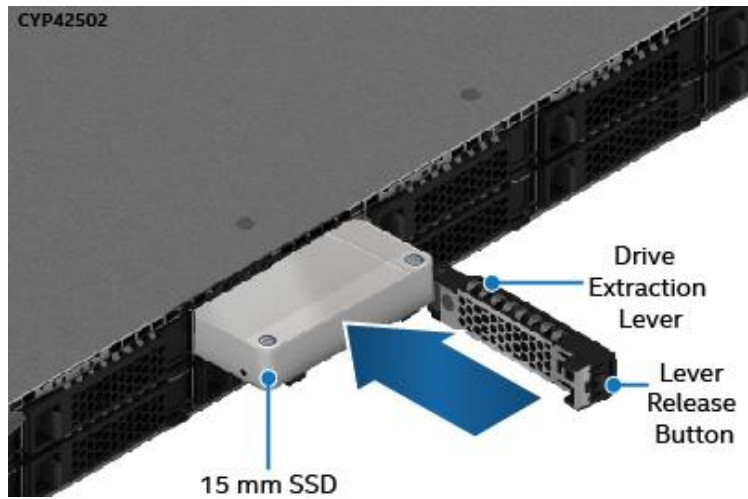
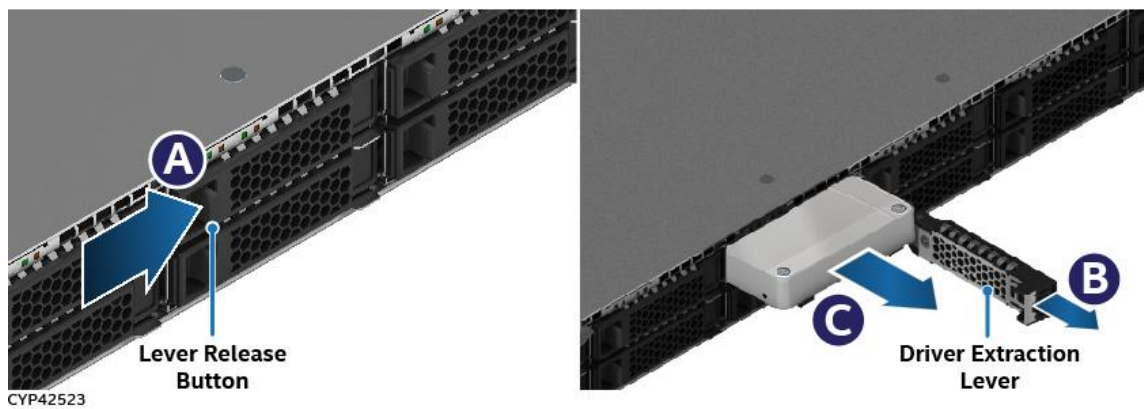

Figure 65. 15 mm Drive Insertion into 2.5" Drive Bay



CYP42523

Figure 66. 15 mm Drive Removal from 2.5" Drive Bay



### 8.1.1.4 Front Drive Bay LED Support

Each drive bay includes two LED indicators, green for drive activity and amber for drive status. Light pipes integrated into the chassis direct light emitted from LEDs mounted next to each drive connector on the backplane to the drive front bay. The light pipes make the LEDs visible from the front of the system.

The following figure shows the 2.5" drive carrier along with LED identification. The LEDs are provided in pairs for two drive bays. The following tables provide the LED states for each LED.

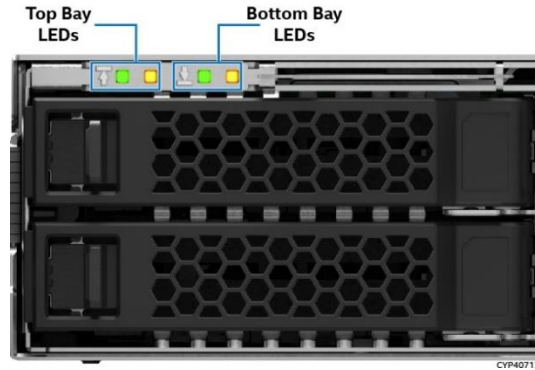

Figure 67. Drive Bay LED Identification

Table 31. Drive Status LED States

	LED State	Drive Status
Amber	Off	No access and no fault
	Solid on	Hard drive fault has occurred
	1 Hz blinking	RAID rebuild in progress
	2 Hz blinking	Locate (identify)

Table 32. Drive Activity LED States

	Condition	Drive Type	LED Behavior
Green	Power on with no drive activity	SAS/NVMe*	LED stays on
		SATA	LED stays off
	Power on with drive activity	SAS/NVMe*	LED blinks off when processing a command
		SATA	LED blinks on when processing a command
	Power on and drive spun down	SAS/NVMe*	LED stays off
		SATA	LED stays off
	Power on and drive spinning up	SAS/NVMe*	LED blinks
		SATA	LED stays off

**Note:** The drive activity LED is driven by signals from the drive itself. Drive vendors may choose to operate the activity LED different from what is described in the above table. Should the activity LED on a given drive type behave differently than what is described, customers should reference the drive vendor specifications for the specific drive model to determine the expected drive activity LED operation.

### 8.1.2 Hot Swap Backplane (HSBP) Support

The server system supports the following backplane options:

- 4 x 2.5" drive combo backplanes with support for SAS/SATA/NVMe\* SSD drives
- 12 x 2.5" drive combo backplanes with support for SAS/SATA/NVMe\* SSD drives

The backplanes are fixed mounted to the back of the drive bay within the chassis as shown in the following figures.

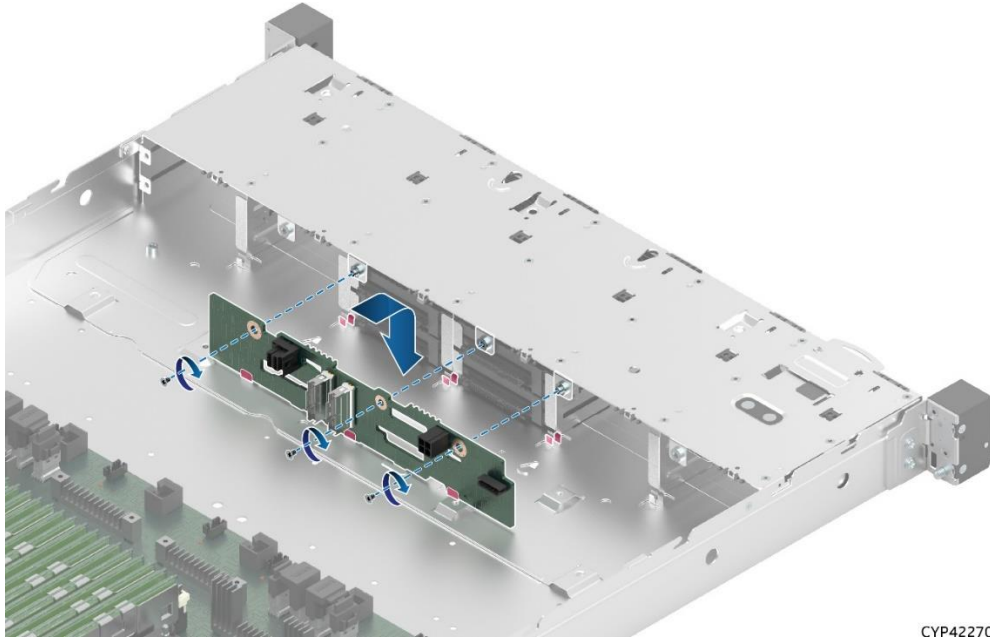

CYP42270

**Figure 68. 4 x 2.5" Hot Swap Backplane Placement**

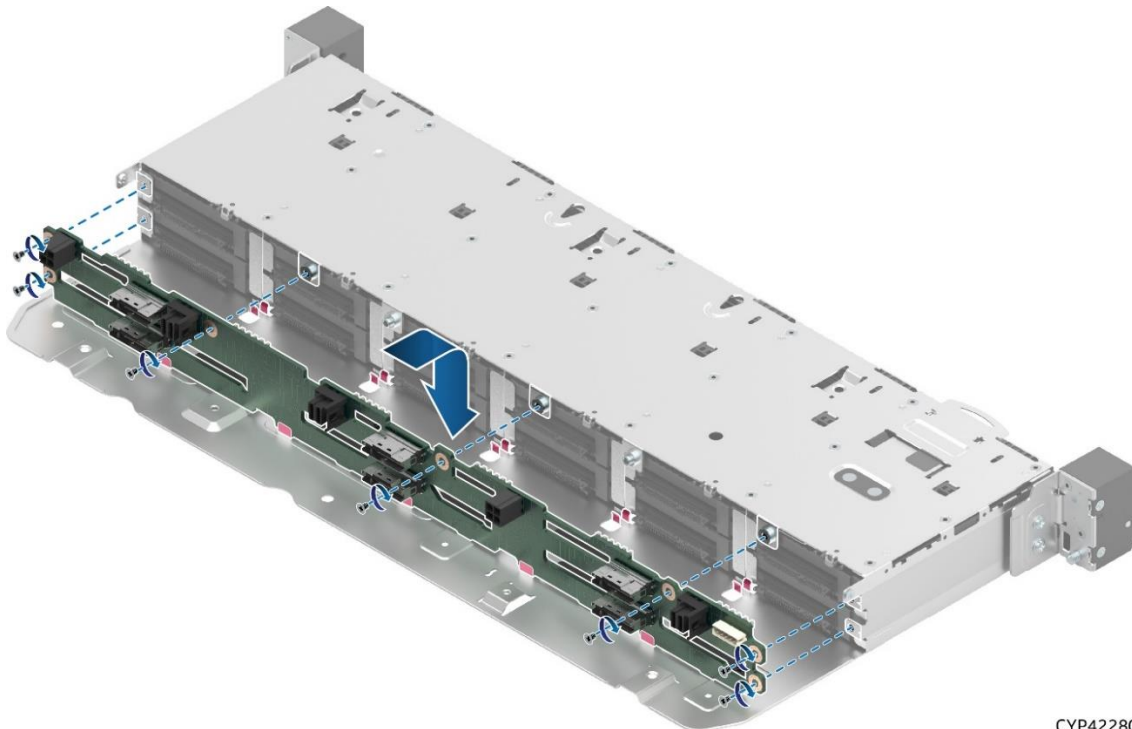

CYP42280

**Figure 69. 12 x 2.5" Hot Swap Backplane Placement**

Backplanes include the following features:

- Up to 12 Gb SAS, up to 6 Gb SAS/SATA/NVMe\* support
- Drive interface connectors
  - 68-pin SFF-8639 – SATA/SAS/NVMe\*
- Hot swap drive support
- Cable connectors
  - SFF-8643 Mini-SAS HD – 12 Gb SAS capable
  - PCIe\* SlimSAS\* interface
  - 1x5-pin connector – I<sup>2</sup>C interface for device status communication to the BMC over slave SMBus\*
  - 2x2-pin connector – power
- SGPIO SFF-8485 interface embedded within the sideband of the Mini-SAS HD connectors
- HSBP microcontroller – Cypress\* CY8C22545-24AXI PsoC\* Programmable System-on-Chip device
- LEDs to indicate drive activity and status for each attached device
- Device presence detect inputs to the microcontroller
- 5 V VR for devices
- 3.3 V VR for microcontroller
- Microcontroller firmware updateable over the I<sup>2</sup>C interface
- FRU EEPROM support
- Temperature sensor using a TMP75 (or equivalent) thermistor implementation with the microcontroller

#### 8.1.2.1 SGPIO Functionality

Backplanes include support for an SFF-8485 compliant SGPIO interface used to activate the status LED. This interface is also monitored by the microcontroller for changing values of FAULT, IDENTIFY, and REBUILD registers. These conditions, in turn, are monitored by the server board BMC for generating corresponding SEL events.

#### 8.1.2.2 I<sup>2</sup>C Functionality

The microcontroller has a host/target I<sup>2</sup>C connection to the server board BMC. The microcontroller is not an IPMB compliant device. The BMC generates SEL events by monitoring registers on the HSBP microcontroller for DRIVE PRESENCE, FAULT, and RAID REBUILD in progress.

#### 8.1.2.3 Power Supply Connector

Power for all backplanes is drawn from the power connector labeled “HSBP\_PWR” on the server board as illustrated in the following figure. Appropriate power cables to support the backplane are included with the system and the backplane accessory kit.

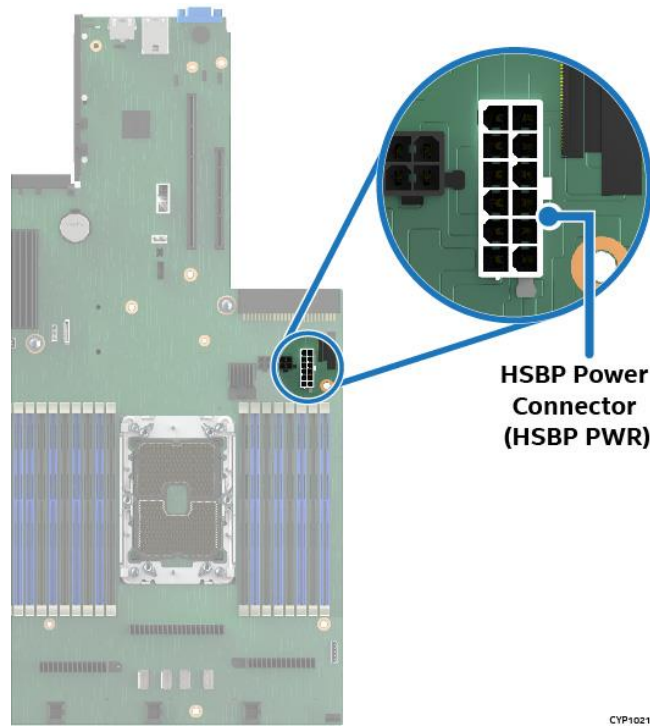

**Figure 70. Server Board HSBP Power Connector**

### 8.1.3 4 x 2.5" Drive SATA/SAS/NVMe\* Combo Backplane

This section applies to the 4 x 2.5" drive SAS/SATA/NVMe\* combo backplane (iPC – CYPHSBP1204).

The 4 x 2.5" drive combo backplane supports different drive configurations. These configurations include SAS or SATA only, NVMe\* only, or a combination of both SAS and NVMe\* drives.

The front side of the backplane includes four 68-pin SFF-8639 drive interface (U.2) connectors, each capable of supporting one SAS, SATA, or NVMe\* drive. The connectors are labeled “SSD\_0”, “SSD\_1”, “SSD\_2”, and “SSD\_3”.

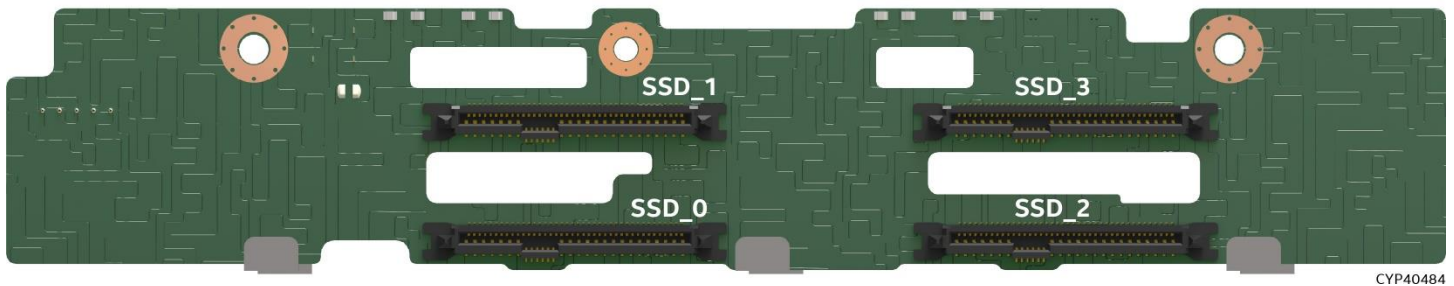

**Figure 71. 4 x 2.5" SAS/SATA/NVMe\* Hot Swap Backplane – Front Side**

The backside of the backplane includes one multiport Mini-SAS HD connector labeled “SAS/SATA Port 0–3”, and two x8 PCIe\* SlimSAS\* connectors, labeled “PCIe\* SSD 0–1” and “PCIe\* SSD 2–3”. Each x8 PCIe\* SlimSAS\* connector is routed to two U.2 connectors on the front side. “PCIe\* SSD 0–1” is routed to “SSD\_0” and “SSD\_1” and “PCIe\* SSD 2–3” is routed to “SSD\_2” and “SSD\_3”.

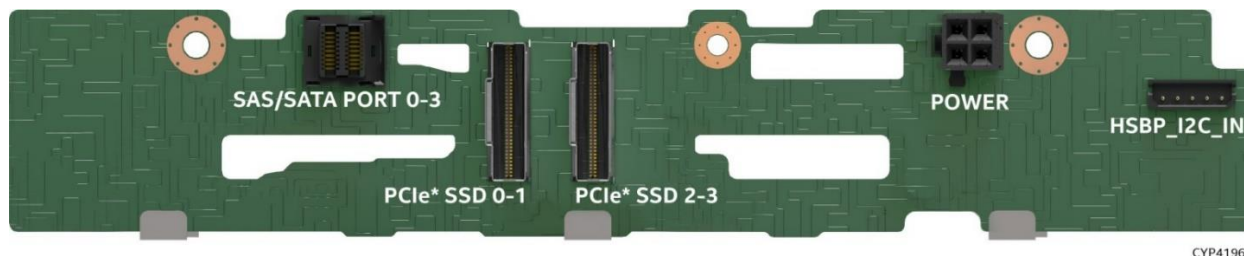

**Figure 72. 4 x 2.5" SAS/SATA/NVMe\* Hot Swap Backplane – Back Side**

### 8.1.3.1 I<sup>2</sup>C Cable Connector

The backplane includes one 1x5 pin cable connector used as a management interface between the server board and the installed backplane.

**Table 33. I<sup>2</sup>C Cable Connector Pinout**

Pin #	Signal Name
1	SMB_3V3_DAT
2	GND
3	SMB_3V3_CLK
4	SMB_ADD0
5	SMB_ADD1

### 8.1.3.2 Multiport Mini-SAS HD Cable Connector

The backplane includes one multiport Mini-SAS HD cable connector (labeled “SAS/SATA PORT 0–3”). This connector provides SGPIO and I/O signals for up to four SAS/SATA devices installed in the hot swap drive bay. Input cables can be routed from matching connectors on the server board (onboard SATA only), from installed add-in SAS/SATA RAID cards or from installed ROC module.

### 8.1.3.3 Power Connector

The backplane includes a 2x2 pin connector supplying power to the backplane. Power is routed to the backplane via a multi-connector power cable from the server board.

**Table 34. Power Connector Pinout**

Pin #	Signal Name
1	GND
2	GND
3	P12V
4	P12V

### 8.1.3.4 PCIe\* SlimSAS\* Connectors

The backplane supports up to four NVMe\* SFF SSDs. The backside of the backplane includes two x8 PCIe\* SlimSAS\* connectors, one for each pair of drive connectors on the front side of the backplane. Each installed NVMe\* drive must have PCIe\* signals cabled to the appropriate backplane PCIe\* SlimSAS\* connector from any of the following PCIe\* signal sources:

- Available onboard PCIe\* SlimSAS\* connectors on the server board.
- Optional tri-mode RAID add-in card
- Riser card with PCIe\* SlimSAS\* connectors



### 8.1.4 12 x 2.5" Drive SATA/SAS/NVMe\* Combo Backplane

This section applies to the 12 x 2.5" drive SAS/SATA/NVMe\* combo backplane (iPC – CYPHSBP1212).

The 12 x 2.5" drive combo backplane supports different drive configurations. These include SAS or SATA only, NVMe\* only, or a combination of both SAS and NVMe\* drives.

The front side of the backplane includes 12 68-pin SFF-8639 drive interface (U.2) connectors, each capable of supporting one SAS, SATA, or NVMe\* drive. The connectors are labeled "SSD\_0" through "SSD\_11".

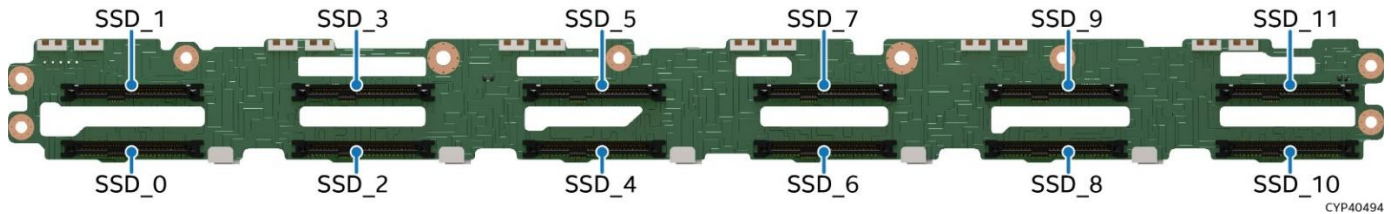

**Figure 73. 12 x 2.5" SAS/SATA/NVMe\* Hot Swap Backplane – Front Side**

The backside of the backplane includes three multiport Mini-SAS HD connectors labeled "SAS/SATA Port 0–3", "SAS/SATA Port 4–7", and "SAS/SATA Port 8–11". Six x8 PCIe\* SlimSAS\* connectors are labeled "PCIe\* SSD 0–1" through "PCIe\* SSD 10–11". Each x8 SlimSAS\* connector is routed to two U.2 connectors on the front side. For example, PCIe\* SSD 0–1 is routed to SSD\_0 and SSD\_1.

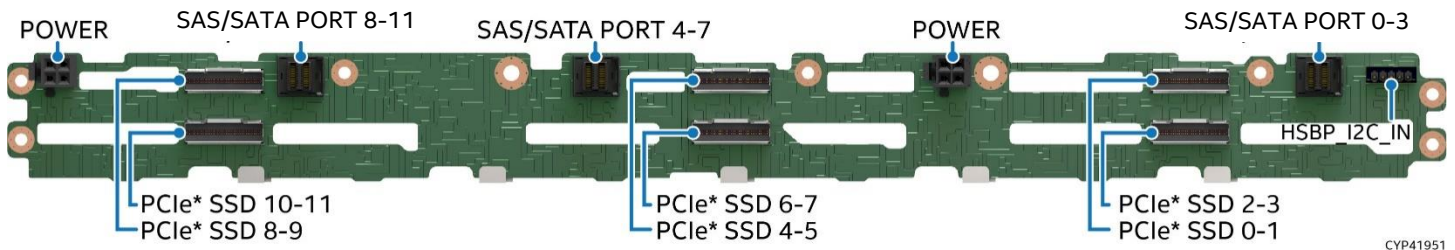

**Figure 74. 12 x 2.5" SAS/SATA/NVMe\* Hot Swap Backplane – Back Side**

#### 8.1.4.1 I<sup>2</sup>C Cable Connector

The backplane includes one 1x5 pin cable connector used as a management interface between the server board and the installed backplane.

**Table 35. I<sup>2</sup>C Cable Connector Pinout**

Pin #	Signal Name
1	SMB_3V3_DAT
2	GND
3	SMB_3V3_CLK
4	NC
5	NC



### 8.1.4.2 Multiport Mini-SAS HD Cable Connectors

The backplane includes three multiport Mini-SAS HD cable connectors (labeled “SAS/SATA PORT 0–3”, “SAS/SATA PORT 4–7”, and “SAS/SATA PORT 8–11”). These connectors provide SGPIO and I/O signals for up to four SAS/SATA devices installed in the hot swap drive bay. Input cables can be routed from matching connectors on the server board (onboard SATA only), or from installed add-in SAS/SATA controller cards for drive configurations of greater than eight hard drives.

### 8.1.4.3 Power Connector

The backplane includes a 2x2 pin connector supplying power to the backplane. Power is routed to each installed backplane via a multi-connector power cable from the server board.

**Table 36. Power Connector Pinout**

Pin #	Signal Name
1	GND
2	GND
3	P12V
4	P12V

### 8.1.4.4 PCIe\* SlimSAS\* Connectors

The backplane supports up to 12 NVMe\* SFF SSDs. The backside of the backplane includes six x8 PCIe\* SlimSAS\* connectors, one for each pair of drive connectors on the front side of the backplane. Each installed NVMe\* drive must have PCIe\* signals cabled to the appropriate backplane PCIe\* SlimSAS\* connector from any of the following PCIe\* signal sources:

- Available onboard PCIe\* SlimSAS\* connectors on the server board.
- Optional tri-mode RAID add-in card
- Riser card with PCIe\* SlimSAS\* connectors

## 8.2 NVMe\* Storage Support

The Intel server system’s advanced server board and backplane design support NVMe\* storage. The server system supports a variety of riser card options for NVMe\* storage support as well as to enhance the base feature set of the system

### 8.2.1 PCIe\* SlimSAS\* Support

The Intel® server system supports PCIe\* NVMe\* SSD connectivity using onboard SlimSAS connectors with PCIe bus lanes routed from the processors. PCIe\* SlimSAS\* is a next generation ultra-high-speed interconnect solution for server systems and storage devices. They offer superior signal integrity performance over standard Mini-SAS HD connectors.

The server board includes eight x4 PCIe\* SlimSAS\* connectors that enable connectivity to NVMe\* drives in the front bay through hot-swap backplanes (HSBPs). These connectors can also be used to connect the server board to a SAS Interposer card (see [Section 8.4.1](#)). PCIe\* lanes from CPU 0 and CPU 1 are each routed to four PCIe\* SlimSAS\* connectors. See the following figure. The CPU 0 PCIe\* SlimSAS\* connectors are labeled “CPU0\_PClE\*\_PortA” through “CPU0\_PClE\*\_PortD” on the server board. The CPU 1 PCIe\* SlimSAS\* connectors are labeled “CPU1\_PClE\*\_PortA” through “CPU1\_PClE\*\_PortD” on the server board.

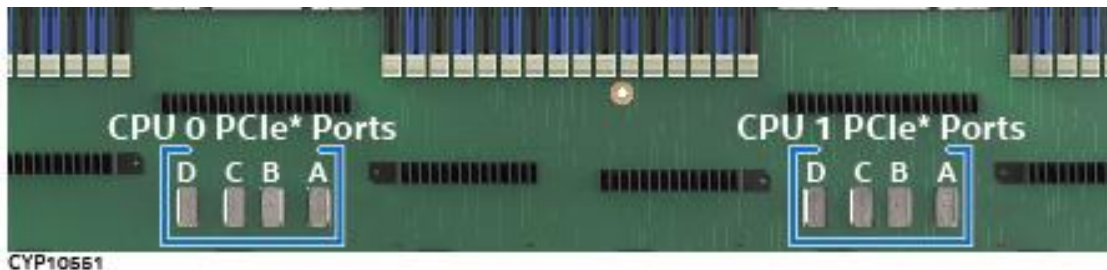

**Figure 75. PCIe\* SlimSAS\* Connectors**

The following table provides the PCIe\* port routing information for the server board PCIe\* SlimSAS connectors.

**Table 37. CPU to PCIe\* NVMe\* SlimSAS\* Connector Routing**

Host	CPU Port	Routed to SlimSAS* Connector
CPU 0	Port 3A	CPU0_PClE*_PortA
	Port 3B	CPU0_PClE*_PortB
	Port 3C	CPU0_PClE*_PortC
	Port 3D	CPU0_PClE*_PortD
CPU 1	Port 3A	CPU1_PClE*_PortA
	Port 3B	CPU0_PClE*_PortB
	Port 3C	CPU1_PClE*_PortC
	Port 3D	CPU0_PClE*_PortD

In addition to the server board PCIe\* SlimSAS connectors, the server system also includes PCIe\* SlimSAS connectors on select riser card options. The PCIe\* NVMe\* Riser Card for Riser Slot #3 (see [Section 8.2.2](#)) supports 2 x8 PCIe\* SlimSAS connectors. Using this riser card option, the server system can support up to four additional NVMe\* drives, depending on system configuration.

**8.2.2 PCIe\* NVMe\* Riser Card for Riser Slot #3 (iPC – CYPRISE3RTM)**

The server system supports one NVMe riser card option for front drive bay support.

The Two-Slot PCIe\* NVMe\* Riser Card, shown in the following figure, supports two x8 PCIe\* SlimSAS connectors labeled “PCIe\_SSD\_0-1” and “PCIe\_SSD\_2-3”. Each connector supports up to two NVMe\* SSDs in the front drive bay through a backplane.

**Note:** This riser card can only be supported in Riser 3 and is NOT compatible for use in riser slots 1 or 2.

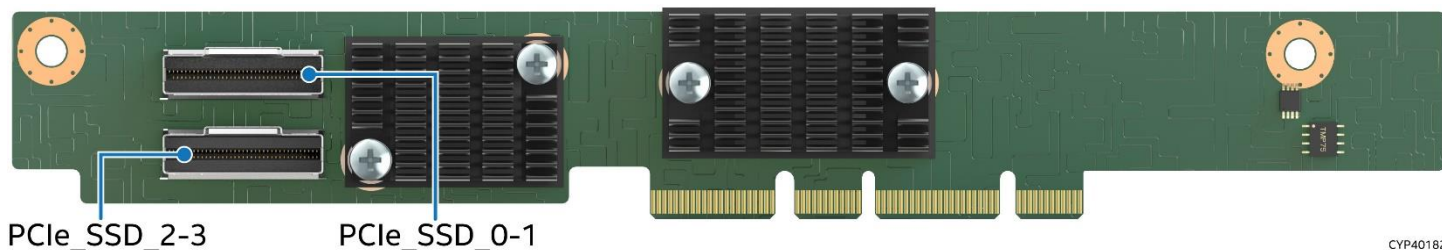

**Figure 76. PCIe\* NVMe\* SlimSAS\* Riser Card for Riser Slot #3**

**Table 38. PCIe\*NVMe\* SlimSAS\* Riser Card Connector Description**

Connector	CPU PCIe* Root Port Mapping
PCIe_SSD_0-1	CPU 1 – Ports 0C through 0D (x8 electrical, x8 mechanical)
PCIe_SSD_2-3	CPU 1 – Ports 0A through 0B (x8 electrical, x8 mechanical)

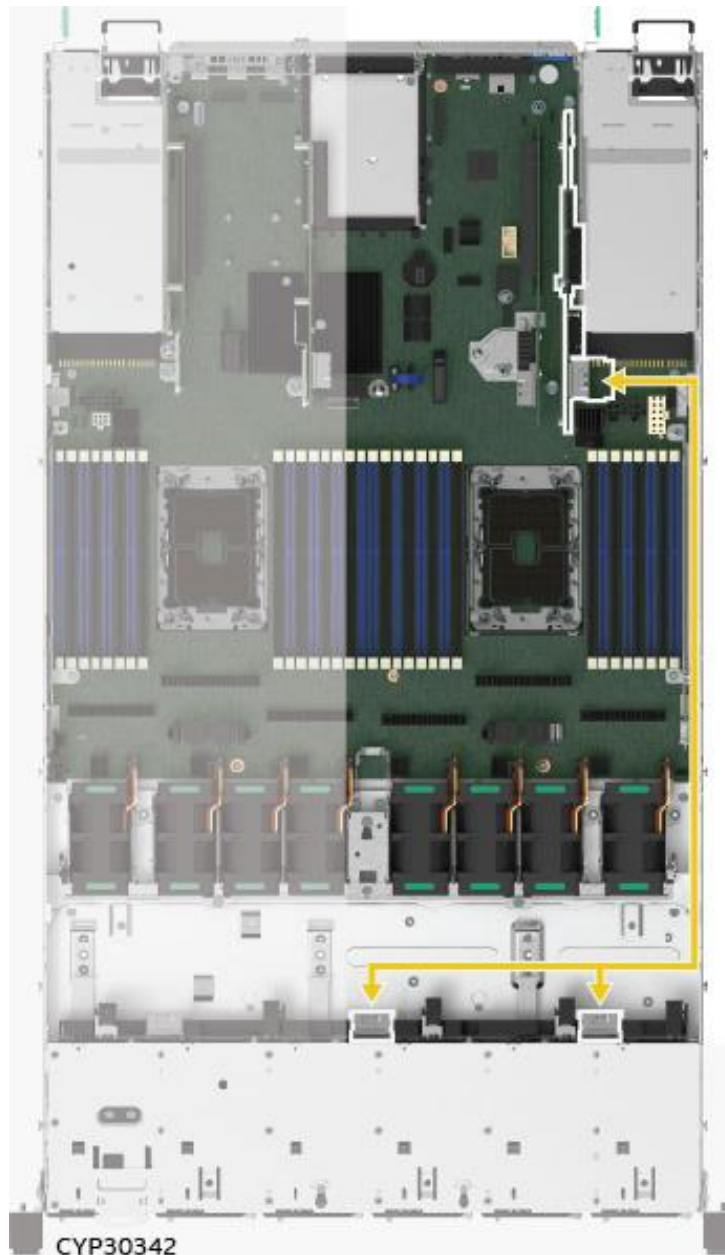

**Figure 77. Cable Routing Between PCIe\* NVMe\* Riser Card and HSBP**

### 8.2.3 Intel® Volume Management Device (Intel® VMD) 2.0 for NVMe\*

Intel® Volume Management Device (Intel® VMD) is hardware logic inside the processor root complex to help manage PCIe\* NVMe\* SSDs. It provides robust hot plug support and status LED management. This allows servicing of storage system NVMe\* SSD media without fear of system crashes or hangs when ejecting or inserting NVMe\* SSD devices on the PCIe\* bus.

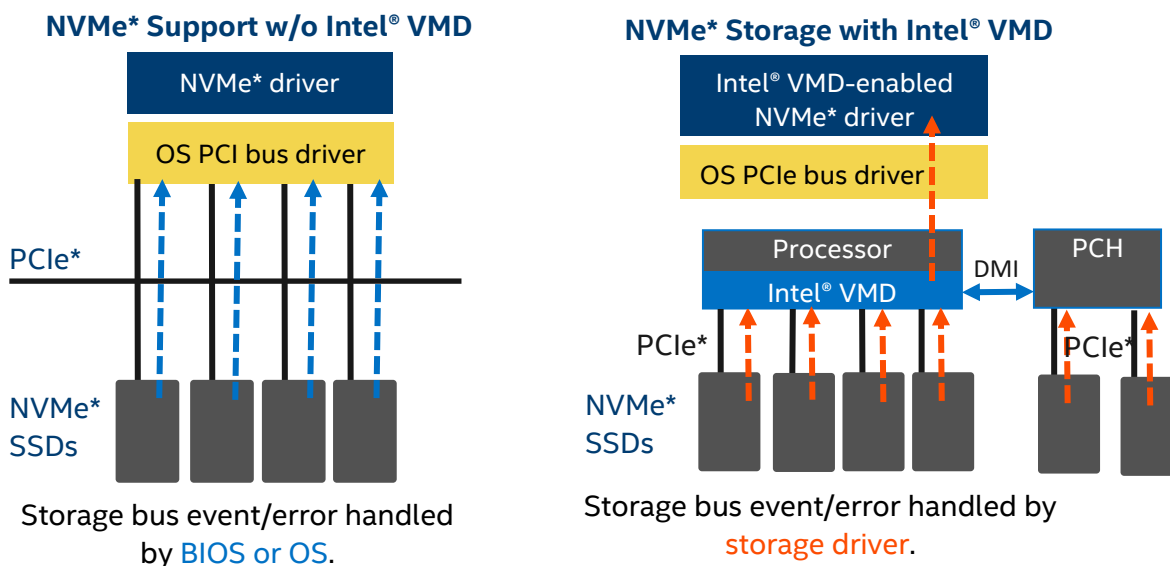

**Figure 78. NVMe\* Storage Bus Event / Error Handling**

Intel® VMD handles the physical management of NVMe\* storage devices as a stand-alone function but can be enhanced when Intel® Virtual RAID on CPU (Intel® VROC) support options are enabled to implement RAID-based storage systems.

#### 8.2.3.1 Intel® VMD 2.0 Features

Intel® VMD 2.0 includes the following features and capabilities:

- Hardware is integrated inside the processor PCIe\* root complex.
- Entire PCIe\* trees are mapped into their own address spaces (domains).
- Each domain manages x16 PCIe\* lanes.
- Can be enabled/disabled in BIOS Setup at x4 lane granularity.
- Driver sets up/manages the domain (enumerate, event/error handling).
- May load an additional child device driver that is Intel® VMD aware.
- Hot plug support - hot insert array of PCIe\* NVMe\* SSDs.
- Support for PCIe\* NVMe\* SSDs only (no network interface controllers (NICs), graphics cards, and so on)
- Maximum of 128 PCIe\* bus numbers per domain.
- Support for Management Component Transport Protocol (MCTP) over SMBus\* only.
- Support for MMIO only (no port-mapped I/O).
- Does not support NTB, Quick Data Tech, Intel® Omni-Path Architecture (Intel® OPA), or SR-IOV.
- Correctable errors do not bring down the system.
- Intel® VMD only manages devices on PCIe\* lanes routed directly from the processor or PCH chipset.
- When Intel® VMD is enabled, the BIOS does not enumerate devices that are behind Intel® VMD. The Intel® VMD-enabled driver is responsible for enumerating these devices and exposing them to the host.

### 8.2.3.2 Enabling Intel® VMD 2.0 for NVMe\* Support

For installed NVMe\* devices to use the Intel® VMD features in the system, Intel® VMD must be enabled on the appropriate processor PCIe\* root ports in BIOS Setup. By default, Intel® VMD support is disabled on all processor PCIe\* root ports in BIOS Setup.

The following table provides the PCIe\* port routing information for the server board PCIe\* SlimSAS connectors.

**Table 39. CPU to PCIe\* NVMe\* SlimSAS\* Connector Routing**

Host	CPU Port	Routed to SlimSAS* Connector
CPU 0	Port 3A	CPU0_PClE*_PortA
	Port 3B	CPU0_PClE*_PortB
	Port 3C	CPU0_PClE*_PortC
	Port 3D	CPU0_PClE*_PortD
CPU 1	Port 3A	CPU1_PClE*_PortA
	Port 3B	CPU0_PClE*_PortB
	Port 3C	CPU1_PClE*_PortC
	Port 3D	CPU0_PClE*_PortD

In BIOS Setup, the Intel® VMD support menu is on the following menu tab: **Advanced > PCI Configuration > Volume Management Device**.

### 8.2.4 Intel® Virtual RAID on Chip (Intel® VROC) for NVMe\*

Intel® VROC supports the following:

- I/O processor with controller (ROC) and DRAM.
- Protected write-back cache – software and hardware that allows recovery from a double fault.
- Isolated storage devices from operating system for error handling.
- Protected R5 data from operating system crash.
- NVMe\* SSD hot plug and surprise removal on processor PCIe\* lanes.
- LED management for PCIe\* attached storage.
- RAID/storage management using Representational State Transfer (RESTful) application programming interfaces (APIs).
- Graphical user interface (GUI) for Linux\*.
- 4K native NVMe\* SSD support.

Enabling Intel® VROC support requires installation of an optional upgrade key on to the server board as shown in the following figure. [Table 40](#) identifies available Intel® VROC upgrade key options.

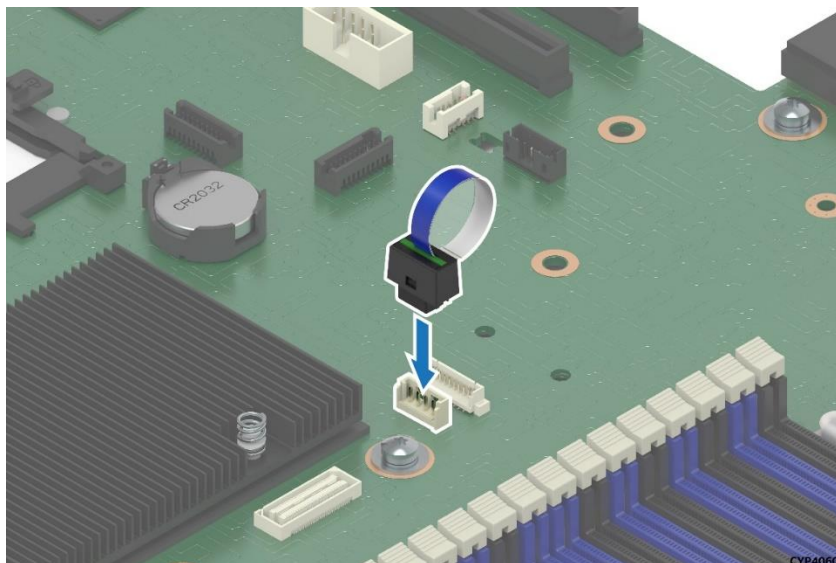

Figure 79. Intel® VROC 7.5 Key Insertion

Table 40. Optional VROC Upgrade Key - Supported NVMe\* RAID Features

NVMe* RAID Major Features	Standard Intel® VROC 7.5 Key (iPC – VROCSTANMOD)	Premium Intel® VROC 7.5 Key (iPC – VROCPREMMOD)	Intel® SSD Only VROC 7.5 Key (iPC – VROCISSDMOD)
Processor-attached NVMe* SSD – high performance	Yes	Yes	Yes
Boot on RAID volume	Yes	Yes	Yes
Third party vendor SSD support	Yes	Yes	No
RAID 0/1/10	Yes	Yes	Yes
RAID 0/1/5/10	No	Yes	Yes
RAID write hole closed (RMFBU replacement)	No	Yes	Yes
Hot plug/ surprise removal (2.5" SSD form factor only)	Yes	Yes	Yes
Enclosure LED management	Yes	Yes	Yes

### 8.2.5 NVMe\* Drive Population Rules for Intel® VROC 7.5

Specific drive population rules must be followed to support NVMe\* RAID 1/5/10. These rules are dependent on how the NVMe\* drives in the front bay are cabled to the PCIe\* sources through the backplane. The backplanes support PCIe\* interfaces from various PCIe\* sources through x8 SlimSAS connectors. The NVMe\* population rules are described in this section.

The backplane supports PCIe\* interfaces from the following sources:

- Server board PCIe\* SlimSAS\* connectors
- Optional Intel® tri-mode RAID add-in cards
- Optional Intel® PCIe\* midplane cards
- PCIe\* NVMe\* riser card in Riser Slot #2 and/or #3

Only NVMe\* drives cabled to PCIe\* sources routed to the same PCIe\* root port of a given processor can be configured into a bootable RAID volume (see Table 24).



**8.2.5.1 Server Board PCIe\* SlimSAS\* Connectors and/or PCIe\* NVMe\* Riser Cards and/or Tri-Mode Intel® RAID Module to 4 x 2.5" Combo Backplane**

When cabling a PCIe\* interface source to the backplane, the cable must be connected only to the drive set highlighted in the following figure.

This backplane does not support PCI\* interface from multiple PCIe\* sources for RAID 1/5/10 enablement. Combining an NVMe\* drive with a SAS/SATA drive within a defined drive set is not supported.

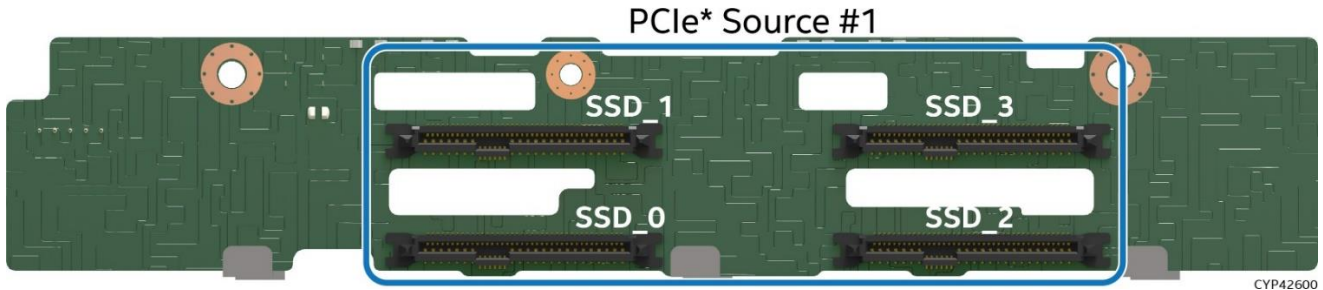

**Figure 80. 4 x 2.5" SAS/SATA/NVMe\* Hot Swap Backplane – Front side**

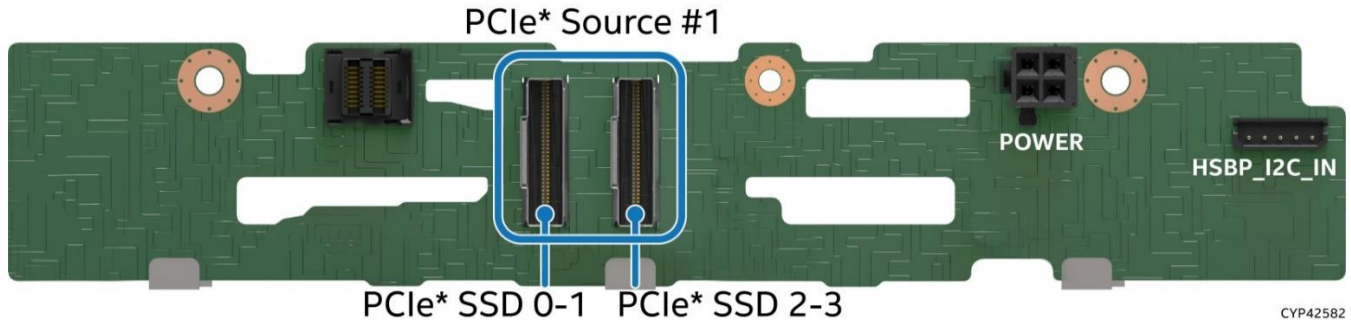

**Figure 81. 4 x 2.5" SAS/SATA/NVMe\* Hot Swap Backplane – Back Side**

**8.2.5.2 Server Board PCIe\* SlimSAS\* Connectors and/or PCIe\* NVMe\* Riser Cards and/or Tri-Mode Intel® RAID Module to 12 x 2.5" Combo Backplane**

When cabling the PCIe\* interfaces from two different sources to the backplane, the cables from each source must be connected in defined drive sets of four, (0-3) or (4-7) or (8-11), as shown in the following figure.

When cabling the backplane from multiple PCIe\* sources, no other drive set combinations beyond the combinations defined below are supported.

Combining an NVMe\* drive with a SAS/SATA drive within a defined drive set is not supported.

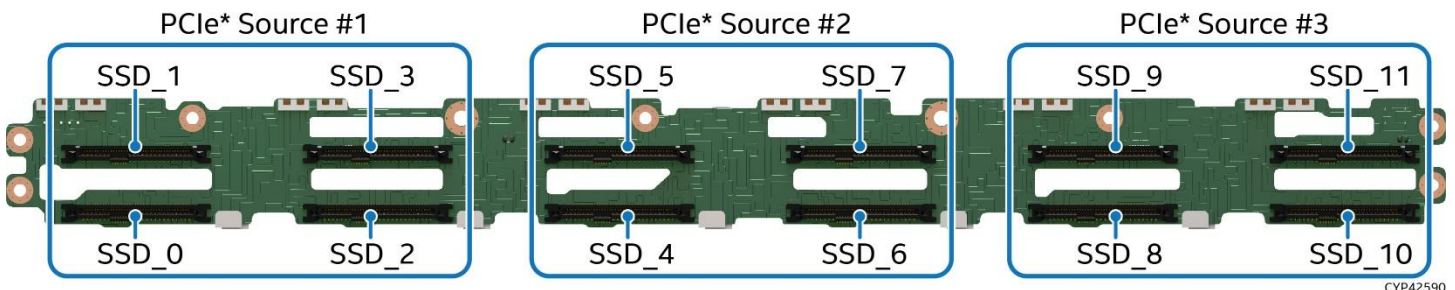

**Figure 82. 12 x 2.5" SAS/SATA/NVMe\* Hot Swap Backplane – Front Side**

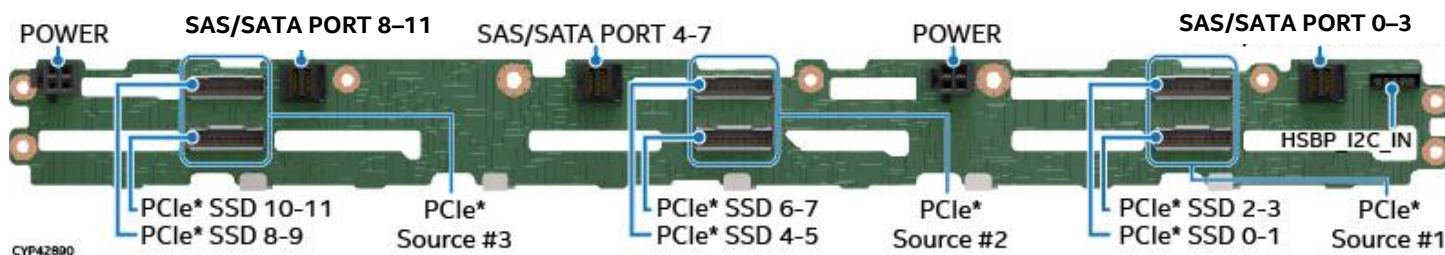

Figure 83. 12 x 2.5" SAS/SATA/NVMe\* Hot Swap Backplane – Back Side

### 8.3 Server Board SATA Support

The server board uses two chipset-embedded AHCI SATA controllers, identified as “SATA” and “sSATA”. The AHCI sSATA controller supports up to two 6 GB/s SATA III ports (sSATA 1 and sSATA 2) using two M.2 SSD connectors. The AHCI SATA controller supports up to eight 6 GB/s SATA III ports on the server board. The following table describes the SATA and sSATA feature support.

Table 41. SATA and sSATA Controller Feature Support

Feature	Description	AHCI Mode	RAID Mode Intel® VROC (SATA RAID)
<b>Native Command Queuing (NCQ)</b>	Allows the device to reorder commands for more efficient data transfers	Supported	Supported
<b>Auto Activate for direct memory access (DMA)</b>	Improves efficiency of data transfer by skipping DMA Activate command after DMA Setup command	Supported	Supported
<b>Hot Plug Support (U.2 Drives Only)</b>	Allows to connect and disconnect devices without prior notification to the system	Supported	Supported
<b>Asynchronous Signal Recovery</b>	Provides a recovery from a loss of signal or establishing communication after hot plug	Supported	Supported
<b>6 Gb/s Transfer Rate</b>	Capable of data transfers up to 6 Gb/s	Supported	Supported
<b>ATAPI Asynchronous Notification</b>	A mechanism for a device to send a notification to the host that the device requires attention	Supported	Supported
<b>Host and Link Initiated Power Management</b>	Capability for the host controller or device to request Partial and Slumber interface power states	Supported	Supported
<b>Staggered Spin-Up</b>	Enables the host to spin up hard drives sequentially to prevent power load problems on boot	Supported	Supported
<b>Command Completion Coalescing</b>	Reduces interrupt and completion overhead by allowing a specified number of commands to complete and then generating an interrupt to process the commands	Supported	N/A

The SATA controller and the sSATA controller can be independently enabled to function in AHCI mode, enabled to function in RAID mode or disabled. These controllers can be independently configured through the BIOS Setup utility under the **Advanced > Mass Storage Controller Configuration** menu screen.

### 8.3.1 SATA Support Through Mini-SAS HD Connectors

The eight SATA ports on the server board are as follows:

- Four ports from the Mini-SAS HD (SFF-8643) connector labeled “SATA\_0-3” on the server board
- Four ports from the Mini-SAS HD (SFF-8643) connector labeled “SATA\_4-7” on the server board

The following figure shows the SATA (0-3) and SATA (4-7) connectors on the server board.

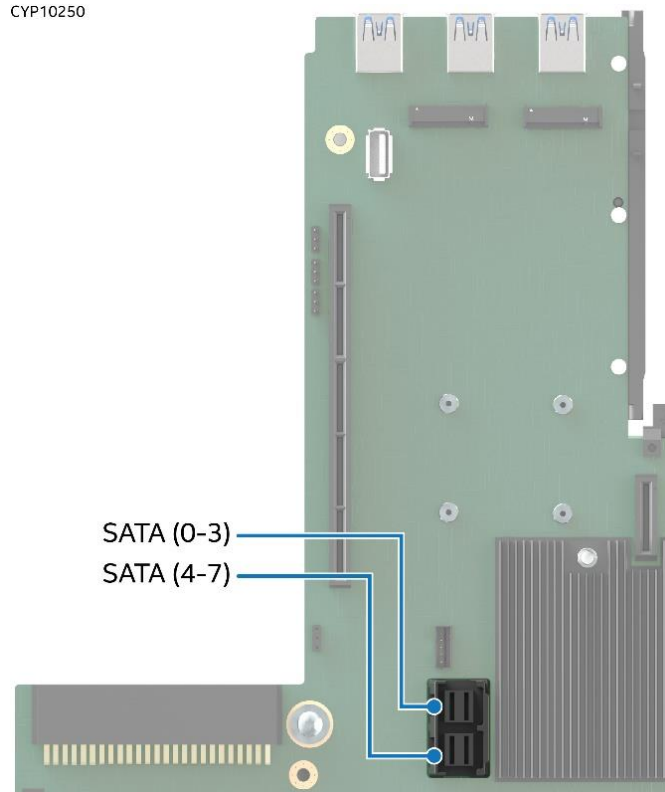

Figure 84. SATA Ports on Server Board

### 8.3.2 SATA Support Through M.2 Connectors

Refer to [Section 8.5](#).

### 8.3.3 Staggered Disk Spin-Up

Because of the high density of disk drives that can be attached to the Intel® C621A chipset onboard AHCI SATA controller and the sSATA controller, the combined startup power demand surge for all drives at once can be much higher than the normal running power requirements. This condition could require a much larger power supply for startup than for normal operations.

To mitigate this condition and lessen the peak power demand during system startup, both the AHCI SATA Controller and the sSATA Controller implement a Staggered Spin-Up capability for the attached drives. This means that the drives are started up separately, with a certain delay between disk drives starting.

The server board SATA controllers can be configured for staggered spin-up in the **Mass Storage Controller Configuration** screen found in the BIOS Setup utility.

### 8.3.4 Intel® Virtual RAID on Chip (Intel® VROC) for SATA

By default, server board RAID options are disabled in BIOS Setup. To enable server board RAID support, access the BIOS Setup utility during POST. The server board RAID options can be found under the **sSATA Controller** or **SATA Controller** options under the following BIOS Setup menu: **Advanced > Mass Storage Controller Configuration**.



**Figure 85. BIOS Setup Mass storage Controller Configuration Screen**

**Note:** RAID partitions created using Intel® VROC 7.5 cannot span across the two embedded SATA controllers. Only drives attached to a common SATA controller can be included in a RAID partition.

Intel® VROC 7.5 offers several options for RAID to meet the needs of the end user. AHCI support provides higher performance and alleviates disk bottlenecks by taking advantage of the independent DMA engines that each SATA port offers in the chipset. Supported RAID levels include 0, 1, 5, and 10.

- **RAID 0** – Uses striping to provide high data throughput, especially for large files in an environment that does not require fault tolerance.
- **RAID 1** – Uses mirroring so that data written to one disk drive simultaneously writes to another disk drive. This action is good for small databases or other applications that require small capacity but complete data redundancy.
- **RAID 5** – Uses disk striping and parity data across all drives (distributed parity) to provide high data throughput, especially for small random access.
- **RAID 10** – A combination of RAID 0 and RAID 1, consists of striped data across mirrored spans. It provides high data throughput and complete data redundancy but uses a larger number of spans.

By using Intel® VROC 7.5, there is no loss of PCIe\* resources or add-in card slot. Intel® VROC 7.5 functionality requires the following:

- The embedded RAID option must be enabled in BIOS Setup.
- Intel® VROC 7.5 option must be selected in BIOS Setup.
- Intel® VROC 7.5 drivers must be loaded for the installed operating system.
- At least two SATA drives needed to support RAID levels 0 or 1.
- At least three SATA drives needed to support RAID level 5.
- At least four SATA drives needed to support RAID level 10.
- NVMe\* SSDs and SATA drives must not be mixed within a single RAID volume.

With Intel® VROC 7.5 software RAID enabled, the following features are made available:

- A boot-time, pre-operating-system environment, text-mode user interface that allows the user to manage the RAID configuration on the system. Its feature set is kept simple to keep size to a minimum but allows the user to create and delete RAID volumes and select recovery options when problems occur. The user interface can be accessed by pressing <CTRL-I> during system POST.
- Boot support when using a RAID volume as a boot disk. It does this by providing Int13 services when a RAID volume needs to be accessed by MS-DOS applications (such as NT loader: NTLDR) and by exporting the RAID volumes to the system BIOS for selection in the boot order.
- At each boot-up, a status of the RAID volumes provided to the user.

## 8.4 SAS Storage Support

The Intel Server System M50CYP1UR family supports front bay SAS/SATA drives using a SAS interposer card and/or supported add-in cards.

### 8.4.1 SAS Interposer Card (iPC – CYPASMODINT) Support

The server system supports the SAS interposer card as an accessory option. This card provides additional SAS/SATA front drive bay support for system configurations having more than eight SAS/SATA drives. The SAS interposer card is shown in the following figure. The SAS interposer card includes a 10-pin I<sup>2</sup>C cable connector used as a management interface to the server board.

The cable kit iPC– CYPBLSLINTKIT must be used to connect the SAS interposer card to the server board. The kit includes:

- (1) – **125/355 mm** splitter power cable connecting server board 12 V power connector to the Interposer card power connector.
- (1) – **610 mm** cable connecting SAS Interposer card I<sup>2</sup>C connector to the server board 10-pin I<sup>2</sup>C header labeled “SAS\_MODULE\_MISC”.
- (1) – **250 mm** cable connecting server board CPU 0 x4 SlimSAS A or CPU 1 x4 SlimSAS D connector to the SAS Interposer card x4 SlimSAS Port A connector.
- (1) – **250 mm** cable connecting CPU 0 x4 SlimSAS B or CPU 1 x4 SlimSAS C connector to the SAS Interposer card x4 SlimSAS Port B connector.

The server system supports several Intel PCIe\* add-in 12 GB RAID modules that can be installed on the SAS interposer card using the 80-pin mezzanine connector labeled “mezzanine\_conn”.

---

**Note:** The server system does not support both SAS Interposer card and Midplane card at the same time.

---



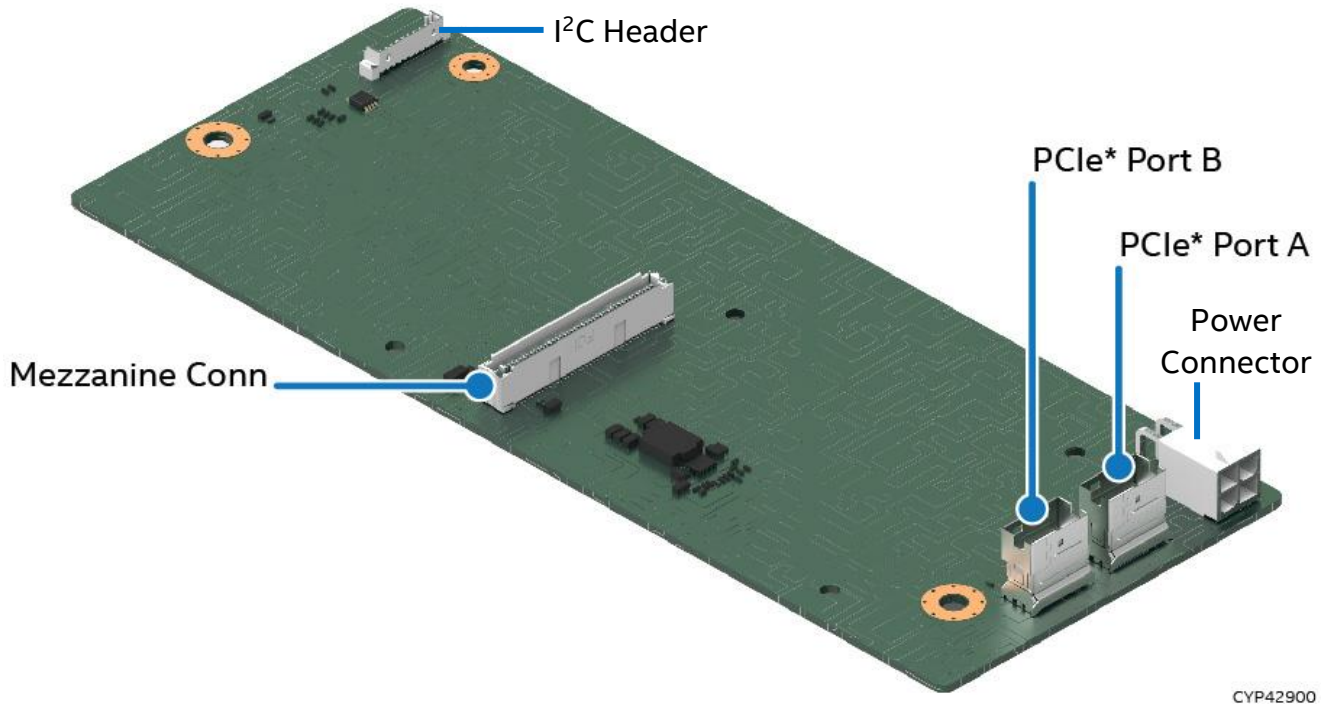

**Figure 86. SAS Interposer Card**

The following figure shows the placement of the SAS interposer card in the server system chassis.

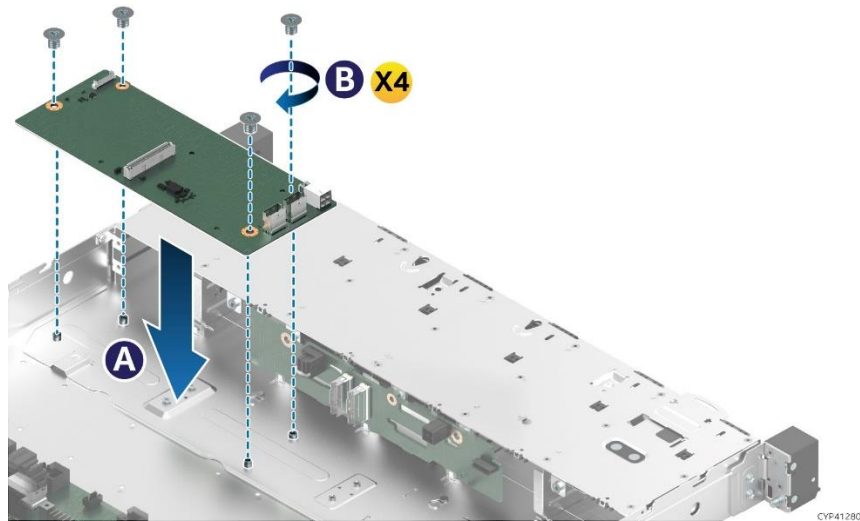

**Figure 87. SAS Interposer Card Placement**

The following figure shows the placement of the SAS RAID module on the SAS interposer card.



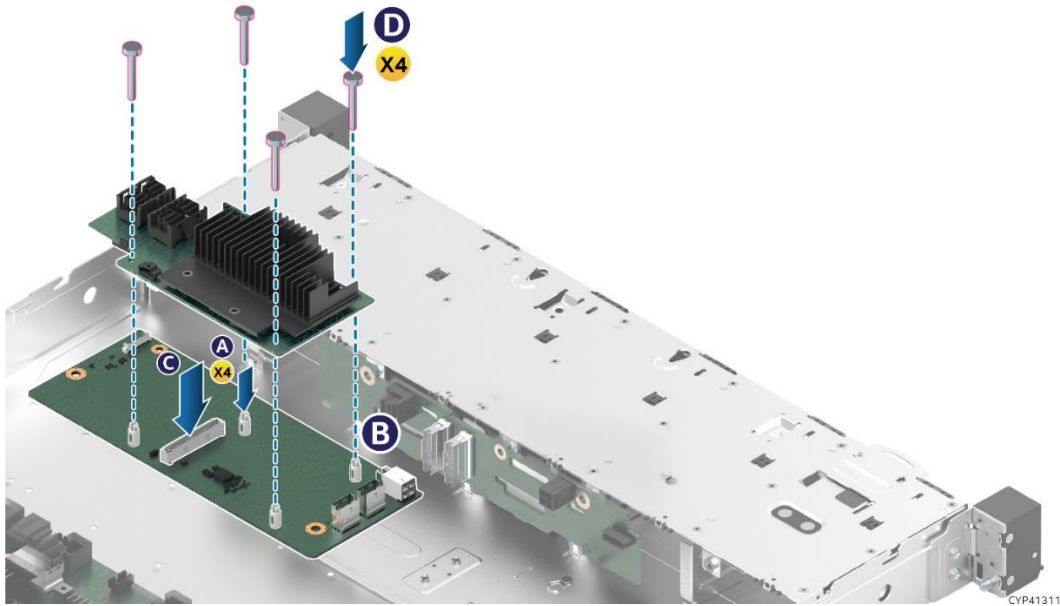

**Figure 88. Intel® SAS RAID Module Placement**

See the *Intel® Server M50CYP Family Configuration Guide* for SAS cabling requirements.

## 8.5 M.2 SSD Storage Support

The server board includes two M.2 SSD connectors as shown in the following figure. The connectors are labeled “M2\_x4PCIE/SSATA\_1 (port 1)” and “M2\_x4PCIE/SSATA\_2 (port 2)” on the board. Each M.2 slot supports a PCIe\* NVMe\* or SATA drive that conforms to a 22110 (110 mm) or 2280 (80 mm) form factor.

Each M.2 slot is connected to four PCIe\* 3.0 lanes from the chipset embedded controller. The M.2 SSDs can be configured into a bootable RAID volume using VROC 7.5 as long as both SSDs are PCIe NVMe or SATA. See [Section 8.2.5](#) and [Section 8.3.4](#) for more information.

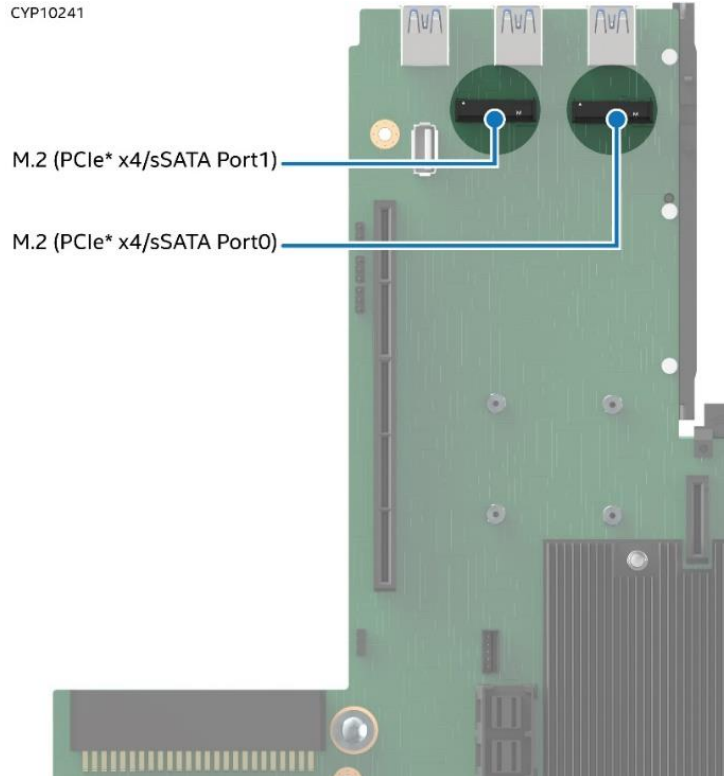

**Figure 89. M.2 Module Connector Location**

## 9. Front Control Panel and I/O

This chapter provides information on the front control panel and I/O available on the front and rear of the server system.

### 9.1 Control Panel Features

The front control panel provides push button system controls and LED indicators for several system features.



Figure 90. Front Control Panel Features

- Power/Sleep Button w/Integrated LED**– Toggles the system power on and off. This button also functions as a sleep button if enabled by an ACPI compliant operating system. Pressing this button sends a signal to the integrated BMC that either powers on or powers off the system. The integrated LED is a single color (green) and supports different indicator states as defined in the following table.

**Note:** After source power is connected, several subsystems are initialized and low-level FRU discovery is performed. This process can take up to 90 seconds. When this process is completed, the ID LED will turn solid on, indicating that the system is ready to be powered on.

Table 42. Power / Sleep LED Functional States

Power Mode	LED	System State	Description
Non-ACPI	Off	Power-off	System power is off, and the BIOS has not initialized the chipset.
	On	Power-on	System power is on
ACPI	Off	S5	Mechanical is off and the operating system has not saved any context to the hard disk.
	On	S0	System and the operating system are up and running.

- System ID Button w/Integrated LED** – Toggles the integrated ID LED and the blue server board system ID LED on and off. Both LEDs are tied together and show the same state. The onboard system ID LED is on the back edge of the server board, viewable from the back of the system. The system ID LEDs are used to identify the system for maintenance when installed in a rack of similar server systems. Two options available for illuminating the system ID LEDs are:
  - The front panel system ID LED button is pushed that causes the LEDs to illuminate to a solid On state until the button is pushed again.
  - An IPMI Chassis Identify command is remotely entered that causes the LEDs to blink for 15 seconds.

- **NMI Button** – When the NMI button is pressed, it puts the server in a halt state and issues a non-maskable interrupt (NMI). This action can be useful when performing diagnostics for a given issue where a memory download is necessary to help determine the cause of the problem. To prevent an inadvertent system halt, the actual NMI button is behind the front control panel faceplate where it is only accessible with the use of a small tipped tool like a pin or paper clip.
- **System Cold Reset Button** – When pressed, this button reboots and re-initializes the system. Unlike the power button, the reset button does not disconnect the power to the system. It just starts the system's Power-On Self-Test (POST) sequence over again.
- **System Status LED** – The system status LED is a bi-color (green/amber) indicator that shows the current health of the server system. The system provides two locations for this feature; one is on the front control panel and the other is on the back edge of the server board, viewable from the back of the system. Both LEDs are tied together and show the same state. The system status LED states are driven by the server board platform management subsystem. When the server is powered down (transitions to the DC-Off state or S5), the BMC is still on standby power and retains the sensor and front panel status LED state established before the power-down event. The following table provides a description of each supported LED state.
- **Drive Activity LED** – The drive activity LED on the front panel indicates drive activity from the server board SATA and sATA storage controllers. The server board also has an I<sup>2</sup>C header labeled “SAS\_MODULE\_MISC” to provide access to this LED for add-in SATA or sATA storage controllers. See [Table 32](#) for SAS/SATA drive activity LED states.

**Table 43. System Status LED State Definitions**

LED State	System State	BIOS Status Description
Off	No AC Power to system	<ul style="list-style-type: none"> <li>• System power is not present.</li> <li>• System is in EuP Lot6 off mode.</li> <li>• System is in S5 soft-Off state.</li> </ul>
Solid green	System is operating normally.	<ul style="list-style-type: none"> <li>• System is running (in S0 State) and its status is healthy. The system is not exhibiting any errors. Source power is present, BMC has booted, and manageability functionality is up and running.</li> <li>• After a BMC reset, and in conjunction with the chassis ID solid on, the BMC is booting Linux*. Control has been passed from BMC uBoot to BMC Linux*. It is in this state for roughly 10–20 seconds.</li> </ul>
Blinking green	System is operating in a degraded state although still functioning, or system is operating in a redundant state but with an impending failure warning.	<ul style="list-style-type: none"> <li>• Redundancy loss such as power-supply or fan. Applies only if the associated platform subsystem has redundancy capabilities.</li> <li>• Fan warning or failure when the number of fully operational fans is less than the minimum number needed to cool the system.</li> <li>• Non-critical threshold crossed – Temperature (including HSBP temp), voltage, input power to power supply, output current for main power rail from power supply and Processor Thermal Control (Therm Ctrl) sensors.</li> <li>• Power supply predictive failure occurred while redundant power supply configuration was present.</li> <li>• Unable to use all installed memory (more than 1 DIMM installed).</li> <li>• Correctable Errors over a threshold and migrating to a spare DIMM (memory sparing). This indicates that the system no longer has spared DIMMs (a redundancy lost condition). Corresponding DIMM LED lit.</li> <li>• In mirrored configuration, when memory mirroring takes place and system loses memory redundancy.</li> <li>• Battery failure.</li> <li>• BMC executing in uBoot. (Indicated by Chassis ID blinking at 3 Hz while Status blinking at 1 Hz). System in degraded state (no manageability). BMC uBoot is running but has not transferred control to BMC Linux*. Server will be in this state 6–8 seconds after BMC reset while it pulls the Linux* image into flash.</li> <li>• BMC Watchdog has reset the BMC.</li> <li>• Power Unit sensor offset for configuration error is asserted.</li> <li>• SSD Hot Swap Controller is off-line or degraded.</li> </ul>

LED State	System State	BIOS Status Description
Blinking green and amber alternately	System is initializing after source power is applied	<ul style="list-style-type: none"> <li>• PFR in the process of updating/authenticating/recovering when source power is connected, system firmware being updated.</li> <li>• System not ready to take power button event/signal.</li> </ul>
Blinking amber	System is operating in a degraded state with an impending failure warning, although still functioning. System is likely to fail.	<ul style="list-style-type: none"> <li>• Critical threshold crossed – Voltage, temperature (including HSBP temp), input power to power supply, output current for main power rail from power supply and PROCHOT (Therm Ctrl) sensors.</li> <li>• VRD Hot asserted.</li> <li>• Minimum number of fans to cool the system not present or failed.</li> <li>• Hard drive fault.</li> <li>• Power Unit Redundancy sensor – Insufficient resources offset (indicates not enough power supplies present).</li> <li>• In non-sparing and non-mirroring mode, if the threshold of correctable errors is crossed within the window.</li> <li>• Invalid firmware image detected during boot up or firmware update.</li> </ul>
Solid amber	Critical/non-recoverable – system is halted. Fatal alarm – system has failed or shut down.	<ul style="list-style-type: none"> <li>• Processor CATERR signal asserted.</li> <li>• MSID mismatch detected (CATERR also asserts for this case).</li> <li>• CPU 0 is missing.</li> <li>• Processor Thermal Trip.</li> <li>• No power good – power fault.</li> <li>• DIMM failure when there is only 1 DIMM present and hence no good memory present.</li> <li>• Runtime memory uncorrectable error in non-redundant mode.</li> <li>• DIMM Thermal Trip or equivalent.</li> <li>• SSB Thermal Trip or equivalent.</li> <li>• Processor ERR2 signal asserted.</li> <li>• BMC/Video memory test failed. (Chassis ID shows blue/solid-on for this condition.)</li> <li>• Both uBoot BMC firmware images are bad. (Chassis ID shows blue/solid-on for this condition.)</li> <li>• 240 VA fault.</li> <li>• Fatal Error in processor initialization: <ul style="list-style-type: none"> <li>○ Processor family not identical</li> <li>○ Processor model not identical</li> <li>○ Processor core/thread counts not identical</li> <li>○ Processor cache size not identical</li> <li>○ Unable to synchronize processor frequency</li> <li>○ Unable to synchronize QPI link frequency</li> </ul> </li> <li>• BMC fail authentication with non-recoverable condition, system hang at T-1; boot PCH only, system hang; PIT failed, system lockdown.</li> </ul>

## 9.2 Front I/O Features

The front I/O provides two USB ports as shown in the following figure.

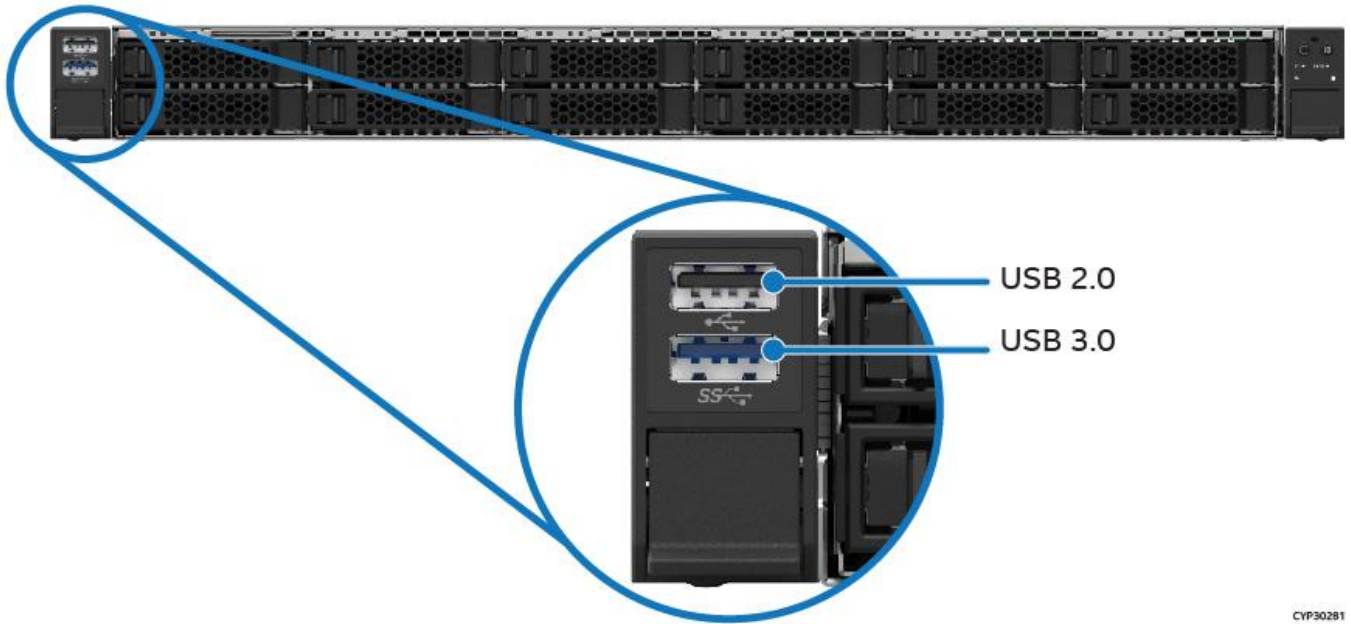

CYP30281

Figure 91. Front I/O Features

## 9.3 Rear I/O Features

The system rear I/O provides serial, video, and USB ports, an area for the OCP adapter area, and a dedicated management network port as shown in the following figure.



CYP30251

Figure 92. Rear I/O Features

### 9.3.1 Remote Management Port

The server system includes a dedicated 1 GbE, RJ45 management port as shown in the following figure.

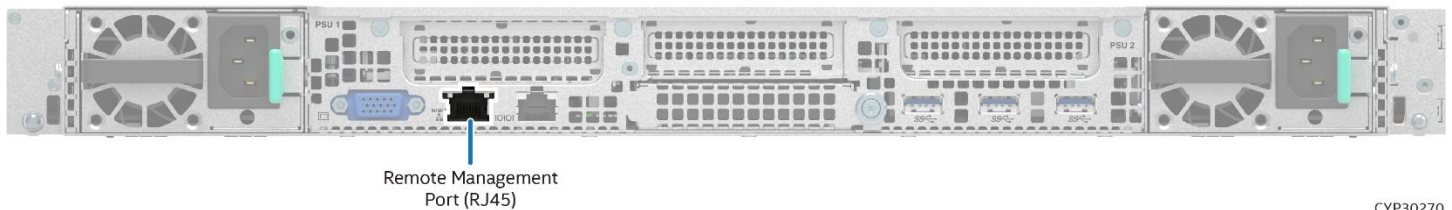

CYP30270

Figure 93. Remote Management Port

### 9.3.2 Serial Port Support

The server board supports two serial ports: Serial Port A and Serial Port B.

Serial Port A is an external RJ45 type connector on the back edge of the server board.

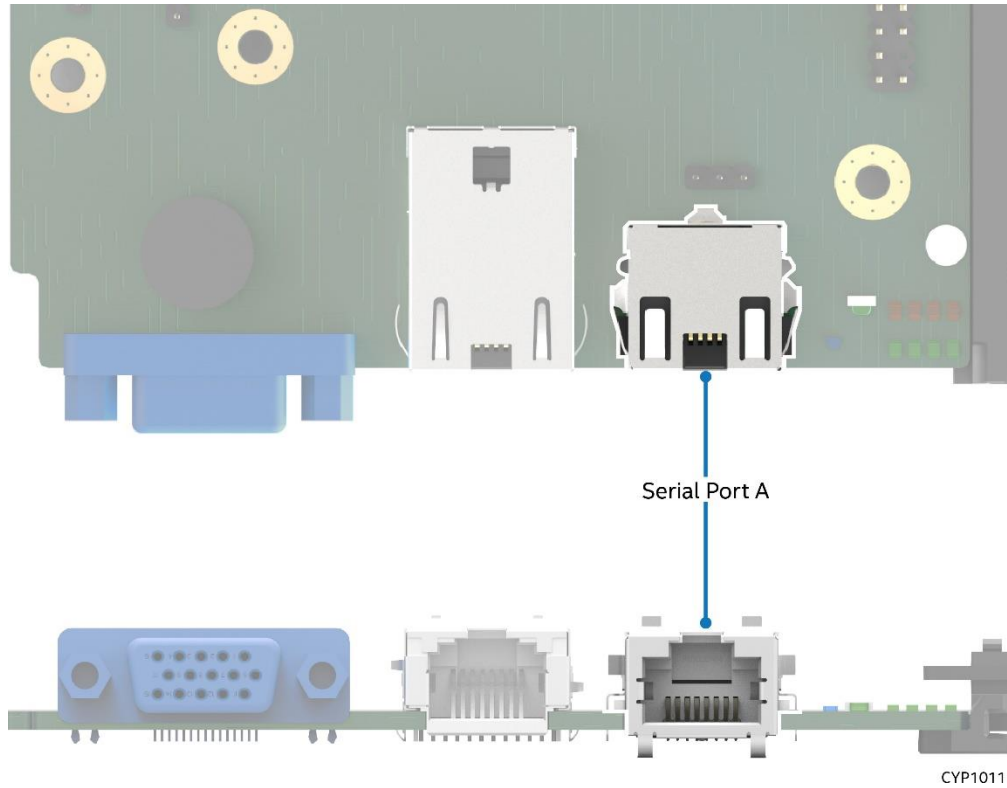

**Figure 94. Serial Port A**

The pin orientation is shown in Figure 95 and the pinout is in [Table 44](#).

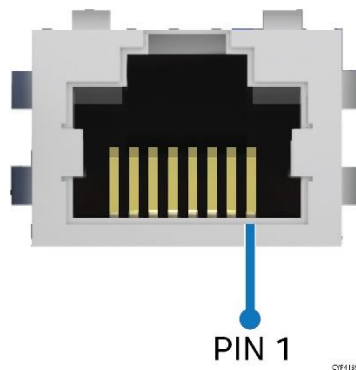

**Figure 95. RJ45 Serial Port A Pin Orientation**

**Table 44. RJ45 Serial Port A Connector Pinout**

Pin #	Signal Name	Pin #	Signal Name
1	RTS	5	RI
2	DTR	6	SIN
3	SOUT	7	DCD or DSR
4	GROUND	8	CTS



**Note:** Pin 7 of the RJ45 Serial Port A connector is configurable to support either a DSR (default) signal or a DCD signal. The Pin 7 signal is changed by moving the jumper on the header labeled “J4A2” from pins 1–2 (default) to pins 2–3 as shown in the following figure.

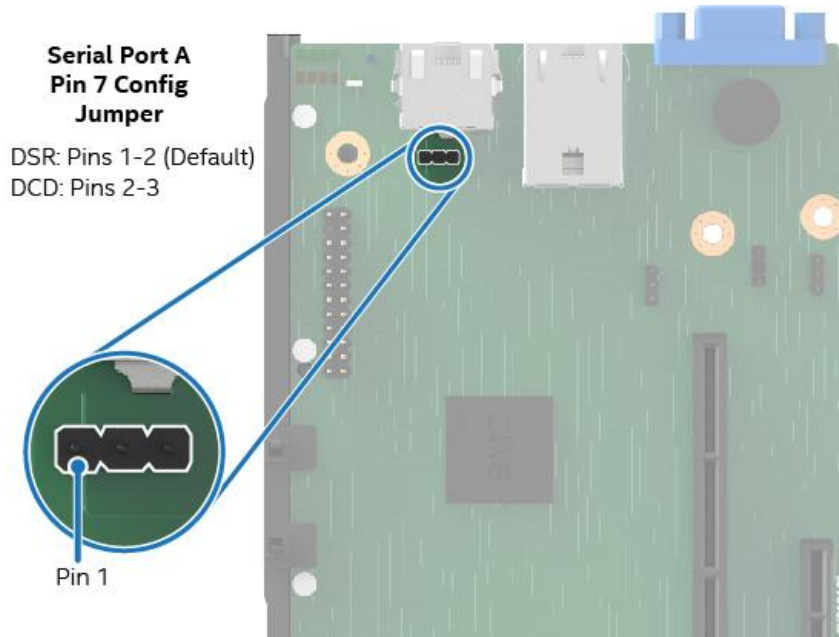

**Figure 96. J4A2 Jumper Header for Serial Port A Pin 7 Configuration**

Serial Port B support is provided through an internal DH-10 header labeled “Serial\_B” on the server board. This header adheres to the DTK pinout specification. The header location is shown in [Figure 97](#) and the pinout is provided in [Table 45](#).

**Note:** Serial B content is provided for reference purposes only and can be supported by purchasing an off-the-shelf serial cable with an external PCIe slot mounting bracket serial connector.

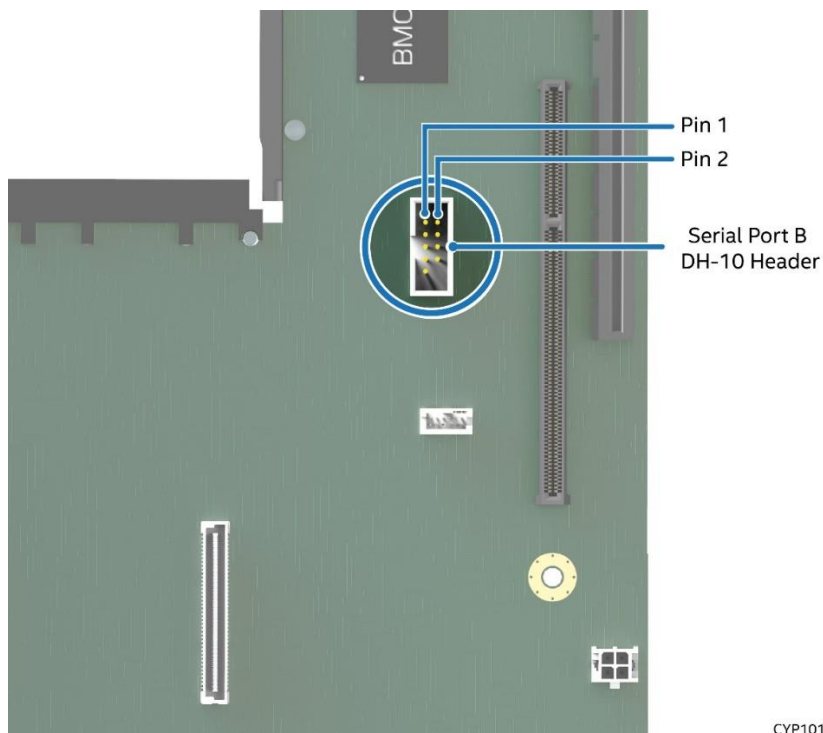

**Figure 97. Serial Port B Header (internal)**

CYP10104

**Table 45. Serial Port B Header Pinout**

Pin#	Signal Description	Pin#	Signal Description
1	DCD	2	DSR
3	SIN	4	RTS
5	SOUT	6	CTS
7	DTR	8	RI
9	GROUND		KEY

### 9.3.3 USB Support

The following figure shows the three rear USB 3.0 ports.

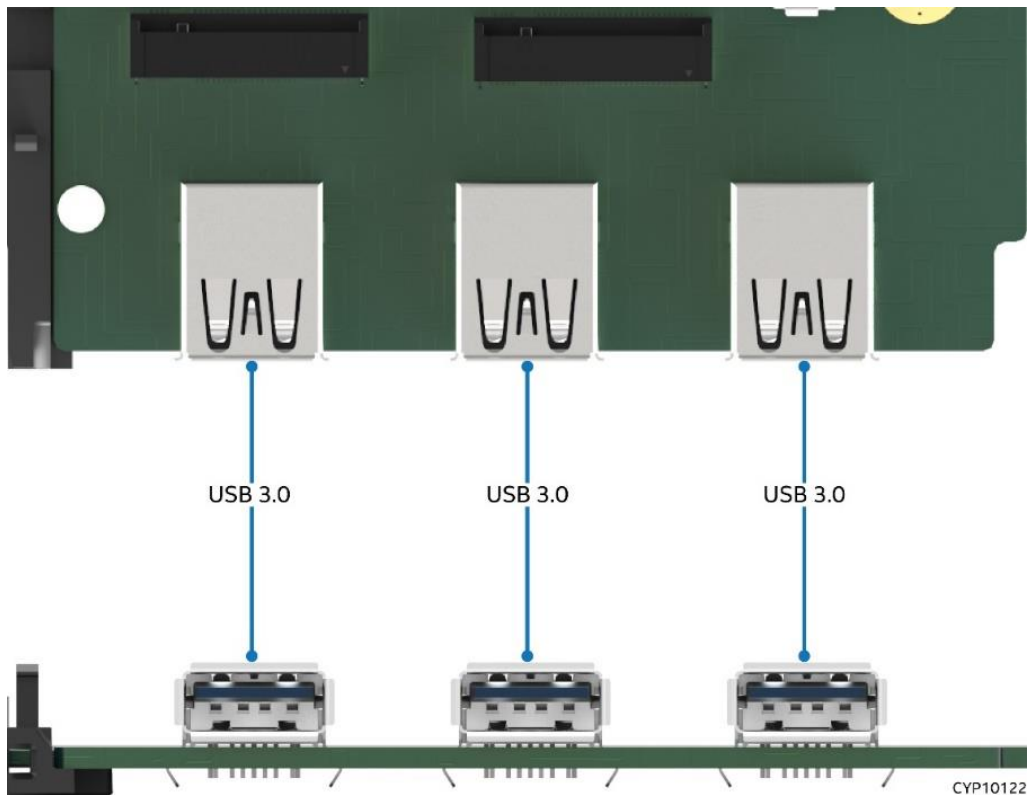

**Figure 98. External USB 3.0 Connector Ports**

### 9.3.3.1 Internal USB 2.0 Type-A Connector

The server board includes one internal Type-A USB 2.0 connector.

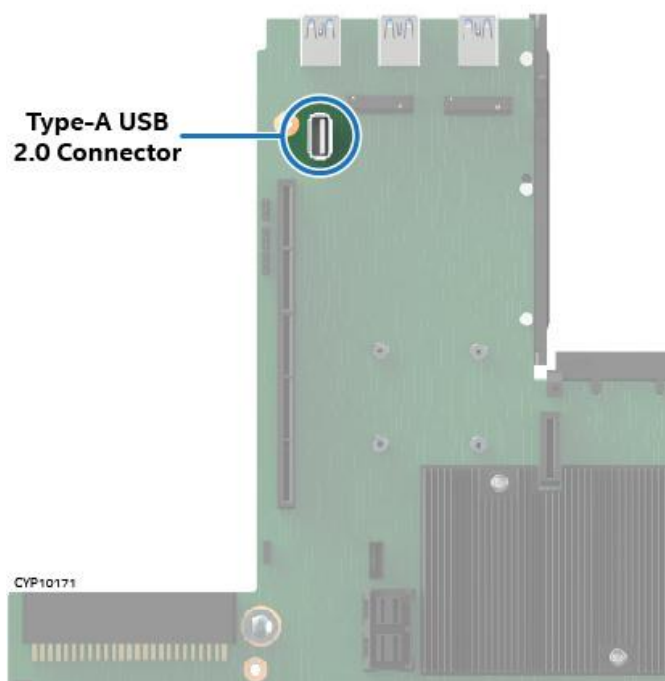

Figure 99. Internal USB 2.0 Type-A Connector

Table 46. Internal USB 2.0 Type-A Connector Pinout

Pin #	Signal Name
1	+5V
2	USB_N
3	USB_P
4	GND

### 9.3.4 Video Support

A standard 15-pin video connector is on the back edge of the server board.

#### 9.3.4.1 Video Resolutions

The graphics controller in the ASPEED\* AST2500 BMC is a VGA-compliant controller with 2D hardware acceleration and full bus master support. With 16 MB of memory reserved, the video controller supports the resolutions specified in the following table.

Table 47. Supported Video Resolutions

2D Mode Resolution	2D Video Support (Color Bit)			
	8 bpp	16 bpp	24 bpp	32 bpp
640 x 480	60, 72, 75, 85	60, 72, 75, 85	Not Supported	60, 72, 75, 85
800 x 600	60, 72, 75, 85	60, 72, 75, 85	Not Supported	60, 72, 75, 85
1024 x 768	60, 72, 75, 85	60, 72, 75, 85	Not Supported	60, 72, 75, 85
1152 x 864	75	75	75	75
1280 x 800	60	60	60	60

2D Mode Resolution	2D Video Support (Color Bit)			
	8 bpp	16 bpp	24 bpp	32 bpp
1280 x 1024	60	60	60	60
1440 x 900	60	60	60	60
1600 x 1200	60	60	Not Supported	Not Supported
1680 x 1050	60	60	Not Supported	Not Supported
1920 x 1080	60	60	Not Supported	Not Supported
1920 x 1200	60	60	Not Supported	Not Supported

### 9.3.4.2 Server Board Video and Add-In Video Adapter Support

The server board includes two options to attach a monitor to the server system:

- A standard 15-pin video connector on the back of the server system.
- Add-in video cards can be used to either replace or complement the onboard video option of the server board.

BIOS Setup includes options to support the desired video operation when an add-in video card is installed.

- When both the **Onboard Video** and **Add-in Video Adapter** options are set to **Enabled**, both video displays can be active. The onboard video is still the primary console and active during BIOS POST. The add-in video adapter is only active under an operating system environment with video driver support.
- When **Onboard Video** is **Enabled** and **Add-in Video Adapter** is **Disabled**, only the onboard video is active.
- When **Onboard Video** is **Disabled** and **Add-in Video Adapter** is **Enabled**, only the add-in video adapter is active.

Configurations with add-in video cards can get more complicated with a dual processor socket board. Some multi-socket boards have PCIe\* slots capable of hosting an add-in video card that is attached to the IIOs of processor sockets other than processor Socket 1. However, only one processor socket can be designated as a legacy VGA socket as required in POST. To provide for this situation, there is the PCI Configuration option **Legacy VGA Socket**. The rules for this option are:

- The **Legacy VGA Socket** option is grayed out and unavailable unless an add-in video card is installed in a PCIe\* slot supported by CPU 1.
- Because the onboard video is hardwired to CPU 0, when **Legacy VGA Socket** is set to **CPU Socket 1**, the onboard video is disabled.

### 9.3.4.3 Dual Monitor Support

The BIOS supports single and dual video when add-in video adapters are installed. No enable/disable option is available in BIOS Setup for dual video. It works when both the **Onboard Video** and **Add-in Video Adapter** options are enabled.

In the single video mode, the onboard video controller or the add-in video adapter is detected during POST.

In dual video mode, the onboard video controller is enabled and is the primary video device while the add-in video adapter is considered as the secondary video device during POST. The add-in video adapter will not be active until the operating system environment is loaded.

## 10. Intel® Light Guided Diagnostics

The server system includes several LED indicators to aid troubleshooting various system-level and board-level faults. This chapter provides information on diagnostic LEDs in the Intel® Server System M50CYP1UR family.

### 10.1 Server Board Light Guided Diagnostics

The following figure shows the location of the LEDs on the server board, except for memory fault LEDs that are provided in Section 10.1.6.

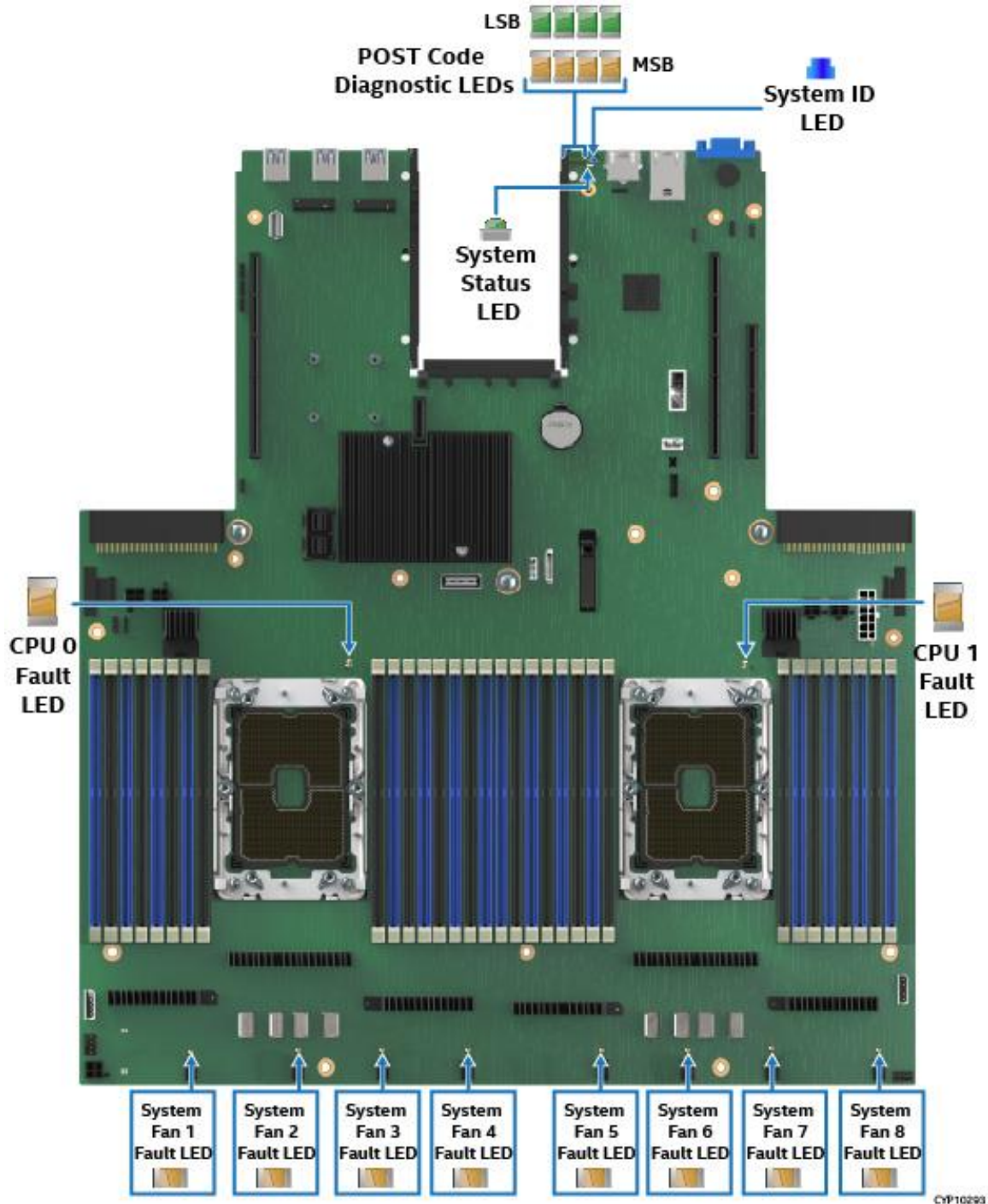
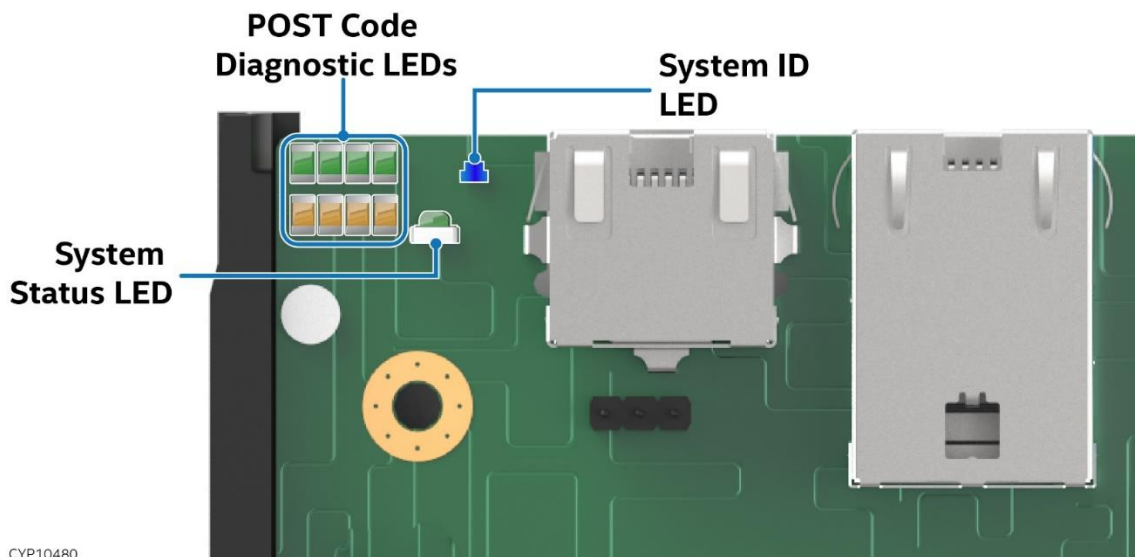

Figure 100. Intel® Server System M50CYP1UR Family Onboard LEDs

The following figure provides an exploded view of the POST code Diagnostic, System ID, and System Status LEDs area.



**Figure 101. Exploded View of POST Code Diagnostic, System ID, and System Status LEDs**

### 10.1.1 Post Code Diagnostic LEDs

A bank of eight POST code diagnostic LEDs are on the back edge of the server board next to the Serial Port A connector (see [Figure 101](#)). During the system boot process, the BIOS executes many platform configuration steps, each of which is assigned a specific hexadecimal POST code number. As each configuration step is started, the BIOS displays the given POST code to the POST code diagnostic LEDs. The purpose of these LEDs is to assist in troubleshooting a system hang condition during the POST process. The diagnostic LEDs can be used to identify the last POST process to be executed. See [Appendix C](#) for a complete description of all supported POST codes.

### 10.1.2 System ID LED

The server board includes a blue system ID LED that is used to visually identify a specific server system installed among many other similar systems. There are two options available for illuminating the System ID LED:

- The front panel ID LED button is pushed that causes the LED to illuminate to a solid On state until the button is pushed again.
- An IPMI Chassis Identify command is remotely entered that causes the LED to blink.

The system ID LED on the server board is tied directly to the system ID LED on the system front panel.

### 10.1.3 System Status LED

The server board includes a bi-color system status LED. The system status LED is tied directly to the system status LED on the front panel. This LED indicates the current health of the system. Possible LED states include solid green, blinking green, solid amber, and blinking amber. For more details, see [Section 9.1](#).

### 10.1.4 BMC Boot/Reset Status LED Indicators

During the BMC boot or BMC reset process, the system status LED and system ID LED are used to indicate BMC boot process transitions and states. A BMC boot occurs when the AC power is first applied. (DC power on/off does not reset BMC). BMC reset occurs after a BMC firmware update, on receiving a BMC cold reset command, and following a reset initiated by the BMC watchdog. [Table 48](#) defines the LED states during the BMC boot/reset process.



**Table 48. BMC Boot / Reset Status LED Indicators**

BMC Boot/Reset State	System ID LED	System Status LED	Comment
BMC/video memory test failed	Solid blue	Solid amber	Non-recoverable condition. Contact an Intel representative for information on replacing this motherboard.
Both universal bootloader (u-Boot) images bad	6 Hz blinking blue	Solid amber	Non-recoverable condition. Contact an Intel representative for information on replacing this motherboard.
BMC in u-Boot	3 Hz blinking blue	1 Hz blinking green	Blinking green indicates degraded state (no manageability), blinking blue indicates u-Boot is running but has not transferred control to BMC Linux*. Server system will be in this state 6–8 seconds after BMC reset while it pulls the Linux* image into flash.
BMC booting Linux*	Solid blue	Solid green	After an AC cycle/BMC reset, indicates that the control has been passed from u-Boot to BMC Linux* itself. It will be in this state for 10-20 seconds.
End of BMC boot/reset process. Normal system operation	Off	Solid green	Indicates BMC Linux* has booted and manageability functionality is up and running. Fault/status LEDs operate as usual.

### 10.1.5 Processor Fault LEDs

The server board includes a processor fault LED for each processor socket (see [Figure 100](#)). The processor fault LED is lit if an MSID mismatch error is detected (that is, processor power rating is incompatible with the board).

Component	Managed by	Color	State	Description
Processor Fault LEDs	BMC	Off	Off	Ok (no errors)
		Solid Amber	On	MSID mismatch

### 10.1.6 Memory Fault LEDs

The server board includes a memory fault LED for each DIMM slot (see the following figure). When the BIOS detects a memory fault condition, it sends an IPMI OEM command (`Set Fault Indication`) to the BMC to turn on the associated memory slot fault LED. These LEDs are only active when the system is in the On state. The BMC does not activate or change the state of the LEDs unless instructed by the BIOS.

Managed	Managed by	Color	State	Description
Memory Fault LED	BMC	Off	Off	Memory working correctly
		Solid Amber	On	Memory failure – detected by BIOS

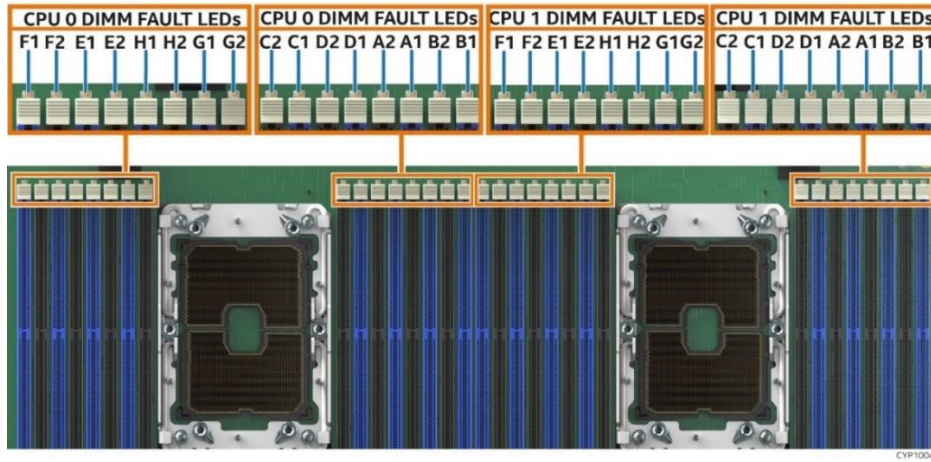

Figure 102. Memory Fault LED Location

### 10.1.7 Fan Fault LEDs

A fan fault LED is associated with each fan (see following figure). The BMC lights a fan fault LED if the associated fan-tach sensor has a lower critical threshold event status asserted. Fan-tach sensors are manual re-arm sensors. Once the lower critical threshold is crossed, the LED remains lit until the sensor is re-armed. These sensors are re-armed at system DC power-on and system reset.

Component	Managed by	Color	State	Description
Fan Fault LED	BMC	Off	Off	Fan working correctly
		Solid Amber	On	Fan failed

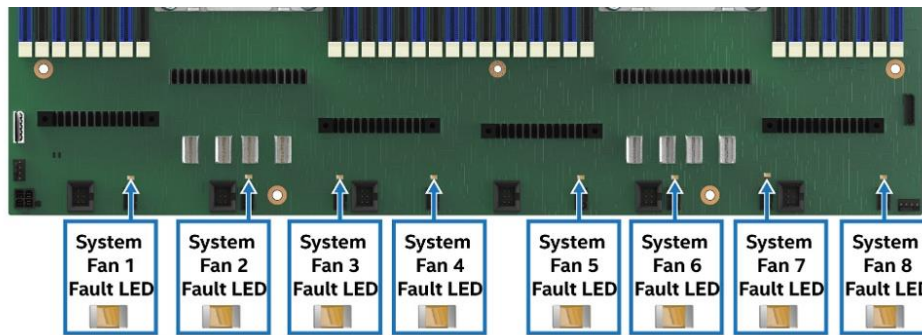

Figure 103. System Fan Fault LEDs

## 10.2 Additional Light Guided Diagnostics

### 10.2.1 Power Supply Status LED

See Section 5.6.1.

### 10.2.2 Front Panel Control LED Indicators

See Section 9.1.

### 10.2.3 Drive Bay LEDs

See Section 8.1.1 for drive status and drive activity LEDs.

### 10.2.4 Drive Activity LED for Front Control Panel

See Section 9.1.

## Appendix A. Getting Help

Available Intel support options with your Intel Server System:

- 24x7 support through Intel's support webpage at <https://www.intel.com/content/www/us/en/support/products/1201/server-products.html>

Information available at the support site includes:

- Latest BIOS, firmware, drivers, and utilities
- Product documentation, setup, and service guides
- Full product specifications, technical advisories, and errata
- Compatibility documentation for memory, hardware add-in cards, and operating systems
- Server and chassis accessory parts list for ordering upgrades or spare parts
- A searchable knowledge base to search for product information throughout the support site

Quick Links:

Use the following links for support on Intel Server Boards and Server Systems	<p style="text-align: center;"><b>Download Center</b></p>  <p style="text-align: center;"><a href="http://www.intel.com/support/downloadserversw">http://www.intel.com/support/downloadserversw</a></p>	<p style="text-align: center;"><b>BIOS Support Page</b></p>  <p style="text-align: center;"><a href="http://www.intel.com/support/server_bios">http://www.intel.com/support/server_bios</a></p>	<p style="text-align: center;"><b>Troubleshooting Boot Issue</b></p>  <p style="text-align: center;"><a href="http://www.intel.com/support/tsboot">http://www.intel.com/support/tsboot</a></p>
<p>Use the following links for support on Intel® Data Center Block (DCB) Integrated Systems*</p> <p>* Intel DCB comes pre-populated with processors, memory, storage, and peripherals based on how it was ordered through the Intel Configure to Order tool.</p>	<p style="text-align: center;"><b>Download Center</b></p>  <p style="text-align: center;"><a href="http://www.intel.com/support/downloadddcbsw">http://www.intel.com/support/downloadddcbsw</a></p>	<p style="text-align: center;"><b>Technical Support Documents</b></p>  <p style="text-align: center;"><a href="http://www.intel.com/support/dcb">http://www.intel.com/support/dcb</a></p>	<p style="text-align: center;"><b>Warranty and Support Info</b></p>  <p style="text-align: center;"><a href="http://www.intel.com/support/dcb_warranty">http://www.intel.com/support/dcb_warranty</a></p>

- If a solution cannot be found at Intel's support site, submit a service request via Intel's online service center at <https://supporttickets.intel.com/servicecenter?lang=en-US>. In addition, you can also view previous support requests. (Login required to access previous support requests)
- Contact an Intel support representative using one of the support phone numbers available at <https://www.intel.com/content/www/us/en/support/contact-support.html> (charges may apply).

Intel also offers Partner Alliance Program members around-the-clock 24x7 technical phone support on Intel® server boards, server chassis, server RAID controller cards, and Intel® Server Management at <https://www.intel.com/content/www/us/en/partner-alliance/overview.html>

---

**Note:** The 24x7 support number is available after logging in to the Intel Partner Alliance website.

---

### Warranty Information

To obtain warranty information, visit [http://www.intel.com/p/en\\_US/support/warranty](http://www.intel.com/p/en_US/support/warranty).

## Appendix B. Integration and Usage Tips

This appendix provides a list of useful information that is unique to the Intel® Server System M50CYP1UR family and should be kept in mind while configuring your server system.

- When adding or removing components or peripherals from the server board, power cords must be disconnected from the server. With power applied to the server, standby voltages are still present even though the server board is powered off.
- The server boards support the 3<sup>rd</sup> Gen Intel® Xeon® Scalable processor family with a Thermal Design Power (TDP) of up to and including 270 Watts. Previous generations of the Intel® Xeon® processor and Intel® Xeon® Scalable processor families are not supported. Server systems using these server boards may or may not meet the TDP design limits of the server board. Validate the TDP limits of the server system before selecting a processor.
- Processors must be installed in order. CPU 0 must be populated for the server board to operate.
- Riser Card Slots #2 and #3 on the server board can only be used in dual processor configurations.
- The riser card slots are specifically designed to support riser cards only. Attempting to install a PCIe\* add-in card directly into a riser card slot on the server board may damage the server board, the add-in card, or both.
- For the best performance, the number of DDR4 DIMMs installed should be balanced across both processor sockets and memory channels.
- On the back edge of the server board, there are eight diagnostic LEDs that display a sequence of POST codes during the boot process. If the server board hangs during POST, the LEDs display the last POST event run before the hang.
- The system status LED is set to a steady amber color for all fatal errors that are detected during processor initialization. A steady amber system status LED indicates that an unrecoverable system failure condition has occurred.
- RAID partitions created using either Intel® VMD cannot span across the two embedded SATA controllers. Only drives attached to a common SATA controller can be included in a RAID partition.
- The FRUSDR utility must be run as part of the initial platform integration process before it is deployed into a live operating environment. Once the initial FRU and SDR data is loaded on to the system, all subsequent system configuration changes automatically update SDR data using the BMC auto configuration feature, without having to run the FRUSDR utility again. However, to ensure the latest sensor data is installed, the SDR data should be updated to the latest available as part of a planned system software update.
- Make sure the latest system software is loaded on the server. This includes system BIOS, BMC firmware, Intel® ME firmware and FRUSDR. The latest system software can be downloaded from <http://downloadcenter.intel.com>.

## Appendix C. Post Code Diagnostic LED Decoder

As an aid in troubleshooting a system hang that occurs during a system POST process, the server board includes a bank of eight POST code diagnostic LEDs on the back edge of the server board.

During the system boot process, Memory Reference Code (MRC) and system BIOS execute several memory initialization and platform configuration routines, each of which is assigned a hex POST code number.

As each process is started, the given POST code number is displayed to the POST code diagnostic LEDs on the back edge of the server board.

During a POST system hang, the displayed POST code can be used to identify the last POST routine that was run before the error occurred, helping to isolate the possible cause of the hang condition.

Each POST code is represented by eight LEDs, four green LEDs and four amber LEDs. The POST codes are divided into two nibbles, an upper nibble and a lower nibble. The upper nibble bits are represented by amber diagnostic LEDs and the lower nibble bits are represented by green diagnostics LEDs. If the bit is set, the corresponding LED is lit. If the bit is clear, the corresponding LED is off. For each set of nibble bits, LED 0 represents the least significant bit (LSB) and LED 3 represents the most significant bit (MSB).

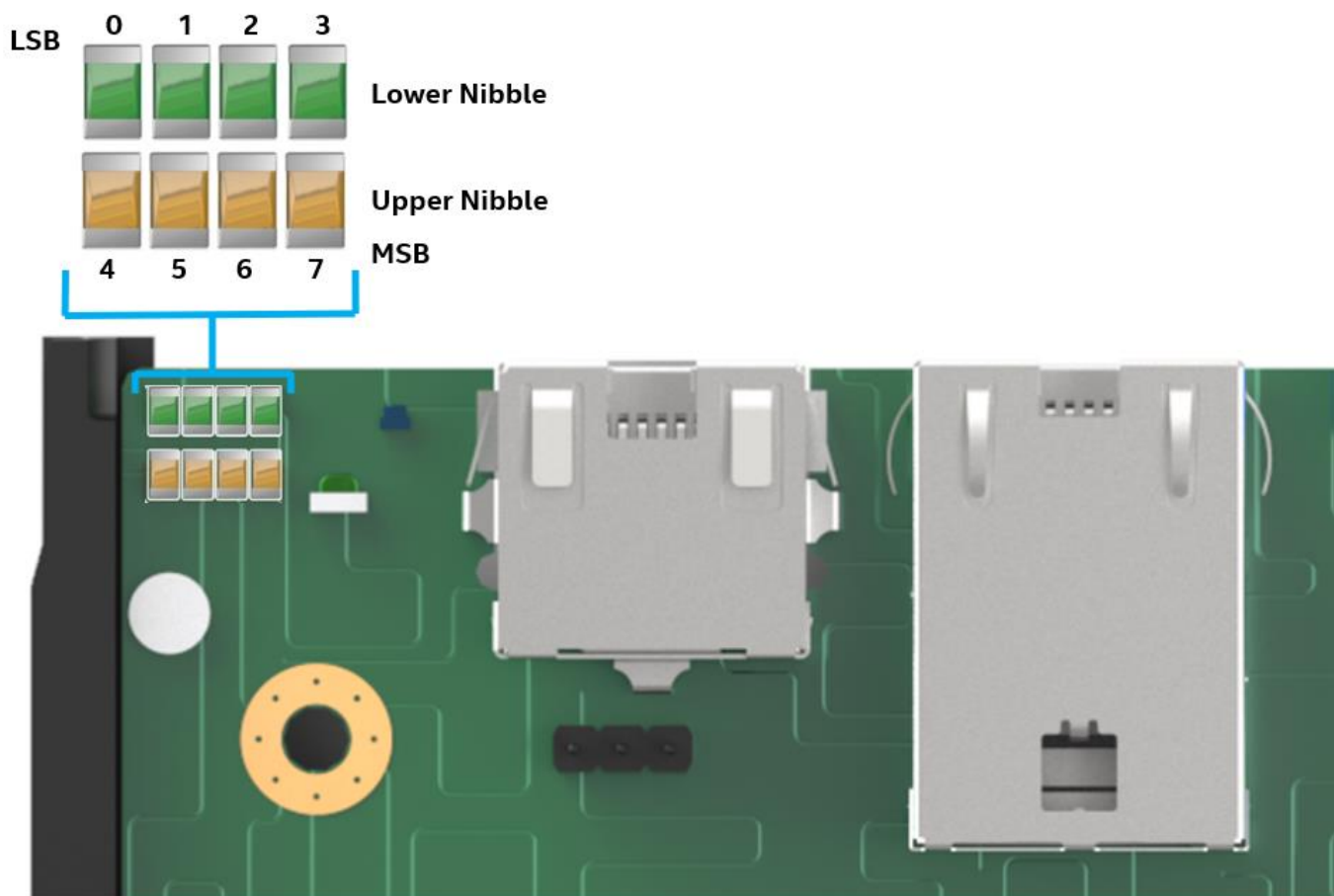

Figure 104. Server Board POST Diagnostic LEDs

**Note:** Diagnostic LEDs are best read and decoded when viewing the LEDs from the back of the system.

In the following example, the BIOS sends a value of AC to the diagnostic LED decoder. The LEDs are decoded as shown in the following table.

**Table 49. POST Progress Code LED Example**

LEDs		Upper Nibble AMBER LEDs				Lower Nibble GREEN LEDs			
		MSB							LSB
		LED #7	LED #6	LED #5	LED #4	LED #3	LED #2	LED #1	LED #0
		8h	4h	2h	1h	8h	4h	2h	1h
Status		ON	OFF	ON	OFF	ON	ON	OFF	OFF
Read Value	Binary	1	0	1	0	1	1	0	0
	Hexadecimal	Ah				Ch			
Result		ACh							

Upper nibble bits = 1010b = Ah; Lower nibble bits = 1100b = Ch; the two Hex Nibble values are combined to create a single ACh POST Progress Code.

### C.1 Early POST Memory Initialization MRC Diagnostic Codes

Memory initialization at the beginning of POST includes multiple functions: discovery, channel training, validation that the DIMM population is acceptable and functional, initialization of the IMC and other hardware settings, and initialization of applicable RAS configurations.

The MRC progress codes are displayed to the diagnostic LEDs that show the execution point in the MRC operational path at each step.

**Table 50. MRC Progress Codes**

Post Code (Hex)	Upper Nibble				Lower Nibble				Description
	8h	4h	2h	1h	8h	4h	2h	1h	
B0	1	0	1	1	0	0	0	0	Detect DIMM population
B1	1	0	1	1	0	0	0	1	Set DDR4 frequency
B2	1	0	1	1	0	0	1	0	Gather remaining SPD data
B3	1	0	1	1	0	0	1	1	Program registers on the memory controller level
B4	1	0	1	1	0	1	0	0	Evaluate RAS modes and save rank information
B5	1	0	1	1	0	1	0	1	Program registers on the channel level
B6	1	0	1	1	0	1	1	0	Perform the JEDEC defined initialization sequence
B7	1	0	1	1	0	1	1	1	Train DDR4 ranks
1	0	0	0	0	0	0	0	1	Train DDR4 ranks
2	0	0	0	0	0	0	1	0	Train DDR4 ranks – Read DQ/DQS training
3	0	0	0	0	0	0	1	1	Train DDR4 ranks – Receive enable training
4	0	0	0	0	0	1	0	0	Train DDR4 ranks – Write DQ/DQS training
5	0	0	0	0	0	1	0	1	Train DDR4 ranks – DDR channel training done
B8	1	0	1	1	1	0	0	0	Initialize CLTT/OLTT
B9	1	0	1	1	1	0	0	1	Hardware memory test and init
BA	1	0	1	1	1	0	1	0	Execute software memory init
BB	1	0	1	1	1	0	1	1	Program memory map and interleaving
BC	1	0	1	1	1	1	0	0	Program RAS configuration
BE	1	0	1	1	1	1	1	0	Execute BSSA RMT
BF	1	0	1	1	1	1	1	1	MRC is done



Should a major memory initialization error occur, preventing the system from booting with data integrity, a beep code is generated, the MRC displays a fatal error code on the diagnostic LEDs, and a system halt command is executed. Fatal MRC error halts do not change the state of the system status LED and they do not get logged as SEL events. [Table 51](#) lists all MRC fatal errors that are displayed to the diagnostic LEDs.

**Note:** Fatal MRC errors display POST error codes that may be the same as BIOS POST progress codes displayed later in the POST process. The fatal MRC codes can be distinguished from the BIOS POST progress codes by the accompanying memory failure beep code of three long beeps as identified in [Table 51](#).

**Table 51. MRC Fatal Error Codes**

Post Code (Hex)	Upper Nibble				Lower Nibble				Description
	8h	4h	2h	1h	8h	4h	2h	1h	
E8	1	1	1	0	1	0	0	0	No usable memory error 01h = No memory was detected from SPD read, or invalid config that causes no operable memory. 02h = Memory DIMMs on all channels of all sockets are disabled due to hardware memtest error. 03h = No memory installed. All channels are disabled.
E9	1	1	1	0	1	0	0	1	Memory is locked by Intel® TXT and is inaccessible
EA	1	1	1	0	1	0	1	0	DDR4 channel training error 01h = Error on read DQ/DQS (Data/Data Strobe) init 02h = Error on Receive Enable 03h = Error on Write Leveling 04h = Error on write DQ/DQS (Data/Data Strobe)
EB	1	1	1	0	1	0	1	1	Memory test failure 01h = Software memtest failure. 02h = Hardware memtest failed.
ED	1	1	1	0	1	1	0	1	DIMM configuration population error 01h = Different DIMM types (RDIMM, LRDIMM) are detected installed in the system. 02h = Violation of DIMM population rules. 03h = The 3rd DIMM slot cannot be populated when QR DIMMs are installed. 04h = UDIMMs are not supported. 05h = Unsupported DIMM Voltage.
EF	1	1	1	0	1	1	1	1	Indicates a CLTT table structure error

## C.2 BIOS POST Progress Codes

The following table provides a list of all POST progress codes.

**Table 52. POST Progress Codes**

Post Code (Hex)	Upper Nibble				Lower Nibble				Description
	8h	4h	2h	1h	8h	4h	2h	1h	
<b>SEC Phase</b>									
01	0	0	0	0	0	0	0	1	First POST code after CPU reset
02	0	0	0	0	0	0	1	0	Microcode load begin
03	0	0	0	0	0	0	1	1	CRAM initialization begin
04	0	0	0	0	0	1	0	0	PEI Cache When Disabled
05	0	0	0	0	0	1	0	1	SEC Core At Power On Begin.
06	0	0	0	0	0	1	1	0	Early CPU initialization during SEC Phase.
<b>UPI RC (Fully leverage without platform change)</b>									
A1	1	0	1	0	0	0	0	1	Collect info such as SBSP, boot mode, reset type, etc.
A3	1	0	1	0	0	0	1	1	Setup minimum path between SBSP and other sockets
A6	1	0	1	0	0	1	1	0	Sync up with PBSPs
A7	1	0	1	0	0	1	1	1	Topology discovery and route calculation
A8	1	0	1	0	1	0	0	0	Program final route
A9	1	0	1	0	1	0	0	1	Program final IO SAD setting
AA	1	0	1	0	1	0	1	0	Protocol layer and other uncore settings
AB	1	0	1	0	1	0	1	1	Transition links to full speed operation
AE	1	0	1	0	1	1	1	0	Coherency settings
AF	1	0	1	0	1	1	1	1	KTI initialization done
<b>PEI Phase</b>									
10	0	0	0	1	0	0	0	0	PEI Core
11	0	0	0	1	0	0	0	1	CPU PEIM
15	0	0	0	1	0	1	0	1	Platform Type Init
19	0	0	0	1	1	0	0	1	Platform PEIM Init
<b>Integrated I/O Progress Codes</b>									
E0	1	1	1	0	0	0	0	0	Integrated I/O Early Init Entry
E1	1	1	1	0	0	0	0	1	Integrated I/O Pre-link Training
E2	1	1	1	0	0		1	0	Integrated I/O EQ Programming
E3	1	1	1	0	0	0	1	1	Integrated I/O Link Training
E4	1	1	1	0	0	1	0	0	Internal Use
E5	1	1	1	0	0	1	0	1	Integrated I/O Early Init Exit
E6	1	1	1	0	0	1	1	0	Integrated I/O Late Init Entry
E7	1	1	1	0	0	1	1	1	Integrated I/O PCIe Ports Init
E8	1	1	1	0	1	0	0	0	Integrated I/O IOAPIC init
E9	1	1	1	0	1	0	0	1	Integrated I/O VTD Init
EA	1	1	1	0	1	0	1	0	Integrated I/O IOAT Init
EB	1	1	1	0	1	0	1	1	Integrated I/O DXF Init
EC	1	1	1	0	1	1	0	0	Integrated I/O NTB Init
ED	1	1	1	0	1	1	0	1	Integrated I/O Security Init
EE	1	1	1	0	1	1	1	0	Integrated I/O Late Init Exit
EF	1	1	1	0	1	1	1	1	Integrated I/O ready to boot

Post Code (Hex)	Upper Nibble				Lower Nibble				Description
	8h	4h	2h	1h	8h	4h	2h	1h	
<b>MRC Progress Codes – At this point the MRC Progress Code sequence is executed.</b>									
31	0	0	1	1	0	0	0	1	Memory Installed
32	0	0	1	1	0	0	1	0	CPU PEIM (CPU Init)
33	0	0	1	1	0	0	1	1	CPU PEIM (Cache Init)
34	0	0	1	1	0	1	0	0	CPU BSP Select
35	0	0	1	1	0	1	0	1	CPU AP Init
36	0	0	1	1	0	1	1	0	CPU SMM Init
4F	0	1	0	0	1	1	1	1	DXE IPL started
<b>Memory Feature Progress Codes</b>									
C1	1	1	0	0	0	0	0	1	Memory POR check
C2	1	1	0	0	0	0	1	0	Internal Use
C3	1	1	0	0	0	0	1	1	Internal Use
C4	1	1	0	0	0	1	0	0	Internal Use
C5	1	1	0	0	0	1	0	1	Memory Early Init
C6	1	1	0	0	0	1	1	0	Display DIMM info in debug mode
C7	1	1	0	0	0	1	1	1	JEDEC Nvdimmm training
C9	1	1	0	0	1	0	0	1	Setup SVL and Scrambling
CA	1	1	0	0	1	0	1	0	Internal Use
CB	1	1	0	0	1	0	1	1	Check RAS support
CC	1	1	0	0	1	1	0	0	Pmem ADR Init
CD	1	1	0	0	1	1	0	1	Internal Use
CE	1	1	0	0	1	1	1	0	Memory Late Init
CF	1	1	0	0	1	1	1	1	Determine MRC boot mode
D0	1	1	0	1	0	0	0	0	MKTME Early Init
D1	1	1	0	1	0	0	0	1	SGX Early Init
D2	1	1	0	1	0	0	1	0	Memory Margin Test
D3	1	1	0	1	0	0	1	1	Internal Use
D5	1	1	0	1	0	1	0	1	Internal Use
D6	1	1	0	1	0	1	1	0	Offset Training Result
<b>DXE Phase</b>									
60	0	1	1	0	0	0	0	0	DXE Core started
62	0	1	1	0	0	0	1	0	DXE Setup Init
68	0	1	1	0	1	0	0	0	DXE PCI Host Bridge Init
69	0	1	1	0	1	0	0	1	DXE NB Init
6A	0	1	1	0	1	0	1	0	DXE NB SMM Init
70	0	1	1	1	0	0	0	0	DXE SB Init
71	0	1	1	1	0	0	0	1	DXE SB SMM Init
72	0	1	1	1	0	0	1	0	DXE SB devices Init
78	0	1	1	1	1	0	0	0	DXE ACPI Init
79	0	1	1	1	1	0	0	1	DXE CSM Init
7D	0	1	1	1	1	1	0	1	DXE Removable Media Detect
7E	0	1	1	1	1	1	1	0	DXE Removable Media Detected
90	1	0	0	1	0	0	0	0	DXE BDS started
91	1	0	0	1	0	0	0	1	DXE BDS connect drivers
92	1	0	0	1	0	0	1	0	DXE PCI bus begin

Post Code (Hex)	Upper Nibble				Lower Nibble				Description
	8h	4h	2h	1h	8h	4h	2h	1h	
93	1	0	0	1	0	0	1	1	DXE PCI Bus HPC Init
94	1	0	0	1	0	1	0	0	DXE PCI Bus enumeration
95	1	0	0	1	0	1	0	1	DXE PCI Bus resource requested
96	1	0	0	1	0	1	1	0	DXE PCI Bus assign resource
97	1	0	0	1	0	1	1	1	DXE CON_OUT connect
98	1	0	0	1	1	0	0	0	DXE CON_IN connect
99	1	0	0	1	1	0	0	1	DXE SIO Init
9A	1	0	0	1	1	0	1	0	DXE USB start
9B	1	0	0	1	1	0	1	1	DXE USB reset
9C	1	0	0	1	1	1	0	0	DXE USB detect
9D	1	0	0	1	1	1	0	1	DXE USB enable
A1	1	0	1	0	0	0	0	1	DXE IDE begin
A2	1	0	1	0	0	0	1	0	DXE IDE reset
A3	1	0	1	0	0	0	1	1	DXE IDE detect
A4	1	0	1	0	0	1	0	0	DXE IDE enable
A5	1	0	1	0	0	1	0	1	DXE SCSI begin
A6	1	0	1	0	0	1	1	0	DXE SCSI reset
A7	1	0	1	0	0	1	1	1	DXE SCSI detect
A8	1	0	1	0	1	0	0	0	DXE SCSI enable
AB	1	0	1	0	1	0	1	1	DXE SETUP start
AC	1	0	1	0	1	1	0	0	DXE SETUP input wait
AD	1	0	1	0	1	1	0	1	DXE Ready to Boot
AE	1	0	1	0	1	1	1	0	DXE Legacy Boot
AF	1	0	1	0	1	1	1	1	DXE Exit Boot Services
B0	1	0	1	1	0	0	0	0	RT Set Virtual Address Map Begin
B1	1	0	1	1	0	0	0	1	RT Set Virtual Address Map End
B2	1	0	1	1	0	0	1	0	DXE Legacy Option ROM init
B3	1	0	1	1	0	0	1	1	DXE Reset system
B4	1	0	1	1	0	1	0	0	DXE USB Hot plug
B5	1	0	1	1	0	1	0	1	DXE PCI BUS Hot plug
B8	1	0	1	1	1	0	0	0	PWRBTN Shutdown
B9	1	0	1	1	1	0	0	1	SLEEP Shutdown
C0	1	1	0	0	0	0	0	0	End of DXE
C7	1	1	0	0	0	1	1	1	DXE ACPI Enable
0	0	0	0	0	0	0	0	0	Clear POST Code
<b>S3 Resume</b>									
E0	1	1	1	0	0	0	0	0	S3 Resume PEIM (S3 started)
E1	1	1	1	0	0	0	0	1	S3 Resume PEIM (S3 boot script)
E2	1	1	1	0	0	0	1	0	S3 Resume PEIM (S3 Video Repost)
E3	1	1	1	0	0	0	1	1	S3 Resume PEIM (S3 OS wake)

## Appendix D. Post Error Codes

Most error conditions encountered during POST are reported using POST error codes. These codes represent specific failures, warnings, or information. POST error codes may be displayed in the error manager display screen and are always logged to the System Event Log (SEL). Logged events are available to system management applications, including remote and Out of Band (OOB) management.

There are exception cases in early initialization where system resources are not adequately initialized for handling POST Error Code reporting. These cases are primarily fatal error conditions resulting from initialization of processors and memory, and they are handled by a diagnostic LED display with a system halt.

Table 53 lists the supported POST error codes. Each error code is assigned an error type that determines the action the BIOS takes when the error is encountered. Error types include minor, major, and fatal. The BIOS action for each is defined as follows:

- **Minor:** An error message may be displayed to the screen or to the BIOS Setup error manager and the POST error code is logged to the SEL. The system continues booting in a degraded state. The user may want to replace the erroneous unit. The “POST Error Pause” option setting in the BIOS Setup does not affect this error.
- **Major:** An error message is displayed to the error manager screen and an error is logged to the SEL. If the BIOS Setup option “Post Error Pause” is enabled, operator intervention is required to continue booting the system. If the BIOS Setup option “POST Error Pause” is disabled, the system continues to boot.

---

**Note:** For 0048 “Password check failed”, the system halts and then, after the next reset/reboot, displays the error code on the error manager screen.

---

- **Fatal:** If the system cannot boot, POST halts and displays the following message: `Unrecoverable fatal error found. System will not boot until the error is resolved. Press <F2> to enter setup.`

When the <F2> key on the keyboard is pressed, the error message is displayed on the error manager screen and an error is logged to the system event log (SEL) with the POST error code. The system cannot boot unless the error is resolved. The faulty component must be replaced. The “POST Error Pause” option setting in the BIOS Setup does not affect this error.

---

**Note:** The POST error codes in the following table are common to all current generation Intel® server platforms. Features present on a given server board/system determine which of the listed error codes are supported.

---

**Table 53. POST Error Messages and Handling**

Error Code	Error Message	Action message	Type
0012	System RTC date/time not set		Major
0048	Password check failed	Put right password.	Major
0140	PCI component encountered a PERR error		Major
0141	PCI resource conflict		Major
0146	PCI out of resources error	Enable Memory Mapped I/O above 4 GB item at SETUP to use 64-bit MMIO.	Major
0191	Processor core/thread count mismatch detected	Use identical CPU type.	Fatal
0192	Processor cache size mismatch detected	Use identical CPU type.	Fatal
0194	Processor family mismatch detected	Use identical CPU type.	Fatal
0195	Processor Intel(R) UPI link frequencies unable to synchronize		Fatal
0196	Processor model mismatch detected	Use identical CPU type.	Fatal
0197	Processor frequencies unable to synchronize	Use identical CPU type.	Fatal
5220	BIOS Settings reset to default settings		Major
5221	Passwords cleared by jumper		Major
5224	Password clear jumper is Set	Recommend reminding user to install BIOS password as BIOS admin password is the master keys for several BIOS security features.	Major
8130	CPU 0 disabled		Major
8131	CPU 1 disabled		Major
8160	CPU 0 unable to apply microcode update		Major
8161	CPU 1 unable to apply microcode update		Major
8170	CPU 0 failed Self-Test (BIST)		Major
8171	CPU 1 failed Self-Test (BIST)		Major
8180	CPU 0 microcode update not found		Minor
8181	CPU 1 microcode update not found		Minor
8190	Watchdog timer failed on last boot.		Major
8198	OS boot watchdog timer failure.		Major
8300	Baseboard Management Controller failed self-test.		Major
8305	Hot Swap Controller failure		Major
83A0	Management Engine (ME) failed self-test.		Major
83A1	Management Engine (ME) Failed to respond.		Major
84F2	Baseboard management controller failed to respond		Major
84F3	Baseboard Management Controller in Update Mode.		Major
84F4	Baseboard Management Controller Sensor Data Record empty.	Update right SDR.	Major
84FF	System Event Log full	Clear SEL through EWS or SELVIEW utility.	Minor
85FC	Memory component could not be configured in the selected RAS mode		Major
8501	Memory Population Error	Plug DIMM at right population.	Major
8502	PMem invalid DIMM population found on the system.	Populate valid POR PMem DIMM population.	Major
8520	Memory failed test/initialization CPU0_DIMM_A1	Remove the disabled DIMM.	Major
8521	Memory failed test/initialization CPU0_DIMM_A2	Remove the disabled DIMM.	Major
8522	Memory failed test/initialization CPU0_DIMM_A3	Remove the disabled DIMM.	Major



Error Code	Error Message	Action message	Type
8523	Memory failed test/initialization CPU0_DIMM_B1	Remove the disabled DIMM.	Major
8524	Memory failed test/initialization CPU0_DIMM_B2	Remove the disabled DIMM.	Major
8525	Memory failed test/initialization CPU0_DIMM_B3	Remove the disabled DIMM.	Major
8526	Memory failed test/initialization CPU0_DIMM_C1	Remove the disabled DIMM.	Major
8527	Memory failed test/initialization CPU0_DIMM_C2	Remove the disabled DIMM.	Major
8528	Memory failed test/initialization CPU0_DIMM_C3	Remove the disabled DIMM.	Major
8529	Memory failed test/initialization CPU0_DIMM_D1	Remove the disabled DIMM.	Major
852A	Memory failed test/initialization CPU0_DIMM_D2	Remove the disabled DIMM.	Major
852B	Memory failed test/initialization CPU0_DIMM_D3	Remove the disabled DIMM.	Major
852C	Memory failed test/initialization CPU0_DIMM_E1	Remove the disabled DIMM.	Major
852D	Memory failed test/initialization CPU0_DIMM_E2	Remove the disabled DIMM.	Major
852E	Memory failed test/initialization CPU0_DIMM_E3	Remove the disabled DIMM.	Major
852F	Memory failed test/initialization CPU0_DIMM_F1	Remove the disabled DIMM.	Major
8530	Memory failed test/initialization CPU0_DIMM_F2	Remove the disabled DIMM.	Major
8531	Memory failed test/initialization CPU0_DIMM_F3	Remove the disabled DIMM.	Major
8532	Memory failed test/initialization CPU0_DIMM_G1	Remove the disabled DIMM.	Major
8533	Memory failed test/initialization CPU0_DIMM_G2	Remove the disabled DIMM.	Major
8534	Memory failed test/initialization CPU0_DIMM_G3	Remove the disabled DIMM.	Major
8535	Memory failed test/initialization CPU0_DIMM_H1	Remove the disabled DIMM.	Major
8536	Memory failed test/initialization CPU0_DIMM_H2	Remove the disabled DIMM.	Major
8537	Memory failed test/initialization CPU0_DIMM_H3	Remove the disabled DIMM.	Major
8538	Memory failed test/initialization CPU1_DIMM_A1	Remove the disabled DIMM.	Major
8539	Memory failed test/initialization CPU1_DIMM_A2	Remove the disabled DIMM.	Major
853A	Memory failed test/initialization CPU1_DIMM_A3	Remove the disabled DIMM.	Major
853B	Memory failed test/initialization CPU1_DIMM_B1	Remove the disabled DIMM.	Major
853C	Memory failed test/initialization CPU1_DIMM_B2	Remove the disabled DIMM.	Major
853D	Memory failed test/initialization CPU1_DIMM_B3	Remove the disabled DIMM.	Major
853E	Memory failed test/initialization CPU1_DIMM_C1	Remove the disabled DIMM.	Major
853F (Go to 85C0)	Memory failed test/initialization CPU1_DIMM_C2	Remove the disabled DIMM.	Major
8540	Memory disabled.CPU0_DIMM_A1	Remove the disabled DIMM.	Major
8541	Memory disabled.CPU0_DIMM_A2	Remove the disabled DIMM.	Major
8542	Memory disabled.CPU0_DIMM_A3	Remove the disabled DIMM.	Major
8543	Memory disabled.CPU0_DIMM_B1	Remove the disabled DIMM.	Major
8544	Memory disabled.CPU0_DIMM_B2	Remove the disabled DIMM.	Major
8545	Memory disabled.CPU0_DIMM_B3	Remove the disabled DIMM.	Major
8546	Memory disabled.CPU0_DIMM_C1	Remove the disabled DIMM.	Major
8547	Memory disabled.CPU0_DIMM_C2	Remove the disabled DIMM.	Major
8548	Memory disabled.CPU0_DIMM_C3	Remove the disabled DIMM.	Major
8549	Memory disabled.CPU0_DIMM_D1	Remove the disabled DIMM.	Major
854A	Memory disabled.CPU0_DIMM_D2	Remove the disabled DIMM.	Major
854B	Memory disabled.CPU0_DIMM_D3	Remove the disabled DIMM.	Major
854C	Memory disabled.CPU0_DIMM_E1	Remove the disabled DIMM.	Major
854D	Memory disabled.CPU0_DIMM_E2	Remove the disabled DIMM.	Major
854E	Memory disabled.CPU0_DIMM_E3	Remove the disabled DIMM.	Major
854F	Memory disabled.CPU0_DIMM_F1	Remove the disabled DIMM.	Major

Error Code	Error Message	Action message	Type
8550	Memory disabled.CPU0_DIMM_F2	Remove the disabled DIMM.	Major
8551	Memory disabled.CPU0_DIMM_F3	Remove the disabled DIMM.	Major
8552	Memory disabled.CPU0_DIMM_G1	Remove the disabled DIMM.	Major
8553	Memory disabled.CPU0_DIMM_G2	Remove the disabled DIMM.	Major
8554	Memory disabled.CPU0_DIMM_G3	Remove the disabled DIMM.	Major
8555	Memory disabled.CPU0_DIMM_H1	Remove the disabled DIMM.	Major
8556	Memory disabled.CPU0_DIMM_H2	Remove the disabled DIMM.	Major
8557	Memory disabled.CPU0_DIMM_H3	Remove the disabled DIMM.	Major
8558	Memory disabled.CPU1_DIMM_A1	Remove the disabled DIMM.	Major
8559	Memory disabled.CPU1_DIMM_A2	Remove the disabled DIMM.	Major
855A	Memory disabled.CPU1_DIMM_A3	Remove the disabled DIMM.	Major
855B	Memory disabled.CPU1_DIMM_B1	Remove the disabled DIMM.	Major
855C	Memory disabled.CPU1_DIMM_B2	Remove the disabled DIMM.	Major
855D	Memory disabled.CPU1_DIMM_B3	Remove the disabled DIMM.	Major
855E	Memory disabled.CPU1_DIMM_C1	Remove the disabled DIMM.	Major
855F (Go to 85D0)	Memory disabled.CPU1_DIMM_C2	Remove the disabled DIMM.	Major
8560	Memory encountered a Serial Presence Detection (SPD) failure.CPU0_DIMM_A1		Major
8561	Memory encountered a Serial Presence Detection (SPD) failure.CPU0_DIMM_A2		Major
8562	Memory encountered a Serial Presence Detection (SPD) failure.CPU0_DIMM_A3		Major
8563	Memory encountered a Serial Presence Detection (SPD) failure.CPU0_DIMM_B1		Major
8564	Memory encountered a Serial Presence Detection (SPD) failure.CPU0_DIMM_B2		Major
8565	Memory encountered a Serial Presence Detection (SPD) failure.CPU0_DIMM_B3		Major
8566	Memory encountered a Serial Presence Detection (SPD) failure.CPU0_DIMM_C1		Major
8567	Memory encountered a Serial Presence Detection (SPD) failure.CPU0_DIMM_C2		Major
8568	Memory encountered a Serial Presence Detection (SPD) failure.CPU0_DIMM_C3		Major
8569	Memory encountered a Serial Presence Detection (SPD) failure.CPU0_DIMM_D1		Major
856A	Memory encountered a Serial Presence Detection (SPD) failure.CPU0_DIMM_D2		Major
856B	Memory encountered a Serial Presence Detection (SPD) failure.CPU0_DIMM_D3		Major
856C	Memory encountered a Serial Presence Detection (SPD) failure.CPU0_DIMM_E1		Major
856D	Memory encountered a Serial Presence Detection (SPD) failure.CPU0_DIMM_E2		Major
856E	Memory encountered a Serial Presence Detection (SPD) failure.CPU0_DIMM_E3		Major
856F	Memory encountered a Serial Presence Detection (SPD) failure.CPU0_DIMM_F1		Major

Error Code	Error Message	Action message	Type
8570	Memory encountered a Serial Presence Detection (SPD) failure.CPU0_DIMM_F2		Major
8571	Memory encountered a Serial Presence Detection (SPD) failure.CPU0_DIMM_F3		Major
8572	Memory encountered a Serial Presence Detection (SPD) failure.CPU0_DIMM_G1		Major
8573	Memory encountered a Serial Presence Detection (SPD) failure.CPU0_DIMM_G2		Major
8574	Memory encountered a Serial Presence Detection (SPD) failure.CPU0_DIMM_G3		Major
8575	Memory encountered a Serial Presence Detection (SPD) failure.CPU0_DIMM_H1		Major
8576	Memory encountered a Serial Presence Detection (SPD) failure.CPU0_DIMM_H2		Major
8577	Memory encountered a Serial Presence Detection (SPD) failure.CPU0_DIMM_H3		Major
8578	Memory encountered a Serial Presence Detection (SPD) failure.CPU1_DIMM_A1		Major
8579	Memory encountered a Serial Presence Detection (SPD) failure.CPU1_DIMM_A2		Major
857A	Memory encountered a Serial Presence Detection (SPD) failure.CPU1_DIMM_A3		Major
857B	Memory encountered a Serial Presence Detection (SPD) failure.CPU1_DIMM_B1		Major
857C	Memory encountered a Serial Presence Detection (SPD) failure.CPU1_DIMM_B2		Major
857D	Memory encountered a Serial Presence Detection (SPD) failure.CPU1_DIMM_B3		Major
857E	Memory encountered a Serial Presence Detection (SPD) failure.CPU1_DIMM_C1		Major
857F (Go to 85E0)	Memory encountered a Serial Presence Detection (SPD) failure.CPU1_DIMM_C2		Major
85C0	Memory failed test/initialization CPU1_DIMM_C3	Remove the disabled DIMM.	Major
85C1	Memory failed test/initialization CPU1_DIMM_D1	Remove the disabled DIMM.	Major
85C2	Memory failed test/initialization CPU1_DIMM_D2	Remove the disabled DIMM.	Major
85C3	Memory failed test/initialization CPU1_DIMM_D3	Remove the disabled DIMM.	Major
85C4	Memory failed test/initialization CPU1_DIMM_E1	Remove the disabled DIMM.	Major
85C5	Memory failed test/initialization CPU1_DIMM_E2	Remove the disabled DIMM.	Major
85C6	Memory failed test/initialization CPU1_DIMM_E3	Remove the disabled DIMM.	Major
85C7	Memory failed test/initialization CPU1_DIMM_F1	Remove the disabled DIMM.	Major
85C8	Memory failed test/initialization CPU1_DIMM_F2	Remove the disabled DIMM.	Major
85C9	Memory failed test/initialization CPU1_DIMM_F3	Remove the disabled DIMM.	Major
85CA	Memory failed test/initialization CPU1_DIMM_G1	Remove the disabled DIMM.	Major
85CB	Memory failed test/initialization CPU1_DIMM_G2	Remove the disabled DIMM.	Major
85CC	Memory failed test/initialization CPU1_DIMM_G3	Remove the disabled DIMM.	Major
85CD	Memory failed test/initialization CPU1_DIMM_H1	Remove the disabled DIMM.	Major
85CE	Memory failed test/initialization CPU1_DIMM_H2	Remove the disabled DIMM.	Major
85CF	Memory failed test/initialization CPU1_DIMM_H3	Remove the disabled DIMM.	Major
85D0	Memory disabled.CPU1_DIMM_C3	Remove the disabled DIMM.	Major
85D1	Memory disabled.CPU1_DIMM_D1	Remove the disabled DIMM.	Major

Error Code	Error Message	Action message	Type
85D2	Memory disabled.CPU1_DIMM_D2	Remove the disabled DIMM.	Major
85D3	Memory disabled.CPU1_DIMM_D3	Remove the disabled DIMM.	Major
85D4	Memory disabled.CPU1_DIMM_E1	Remove the disabled DIMM.	Major
85D5	Memory disabled.CPU1_DIMM_E2	Remove the disabled DIMM.	Major
85D6	Memory disabled.CPU1_DIMM_E3	Remove the disabled DIMM.	Major
85D7	Memory disabled.CPU1_DIMM_F1	Remove the disabled DIMM.	Major
85D8	Memory disabled.CPU1_DIMM_F2	Remove the disabled DIMM.	Major
85D9	Memory disabled.CPU1_DIMM_F3	Remove the disabled DIMM.	Major
85DA	Memory disabled.CPU1_DIMM_G1	Remove the disabled DIMM.	Major
85DB	Memory disabled.CPU1_DIMM_G2	Remove the disabled DIMM.	Major
85DC	Memory disabled.CPU1_DIMM_G3	Remove the disabled DIMM.	Major
85DD	Memory disabled.CPU1_DIMM_H1	Remove the disabled DIMM.	Major
85DE	Memory disabled.CPU1_DIMM_H2	Remove the disabled DIMM.	Major
85DF	Memory disabled.CPU1_DIMM_H3	Remove the disabled DIMM.	Major
85E0	Memory encountered a Serial Presence Detection (SPD) failure.CPU1_DIMM_C3		Major
85E1	Memory encountered a Serial Presence Detection (SPD) failure. CPU1_DIMM_D1		Major
85E2	Memory encountered a Serial Presence Detection (SPD) failure.CPU1_DIMM_D2		Major
85E3	Memory encountered a Serial Presence Detection (SPD) failure.CPU1_DIMM_D3		Major
85E4	Memory encountered a Serial Presence Detection (SPD) failure.CPU1_DIMM_E1		Major
85E5	Memory encountered a Serial Presence Detection (SPD) failure.CPU1_DIMM_E2		Major
85E6	Memory encountered a Serial Presence Detection (SPD) failure.CPU1_DIMM_E3		Major
85E7	Memory encountered a Serial Presence Detection (SPD) failure.CPU1_DIMM_F1		Major
85E8	Memory encountered a Serial Presence Detection (SPD) failure.CPU1_DIMM_F2		Major
85E9	Memory encountered a Serial Presence Detection (SPD) failure.CPU1_DIMM_F3		Major
85EA	Memory encountered a Serial Presence Detection (SPD) failure.CPU1_DIMM_G1		Major
85EB	Memory encountered a Serial Presence Detection (SPD) failure. CPU1_DIMM_G2		Major
85EC	Memory encountered a Serial Presence Detection (SPD) failure.CPU1_DIMM_G3		Major
85ED	Memory encountered a Serial Presence Detection (SPD) failure.CPU1_DIMM_H1		Major
85EE	Memory encountered a Serial Presence Detection (SPD) failure.CPU1_DIMM_H2		Major
85EF	Memory encountered a Serial Presence Detection (SPD) failure.CPU1_DIMM_H3		Major
8604	POST Reclaim of non-critical NVRAM variables		Minor
8605	BIOS Settings are corrupted		Major
8606	NVRAM variable space was corrupted and has been reinitialized		Major

Error Code	Error Message	Action message	Type
8607	Recovery boot has been initiated. Note: The Primary BIOS image may be corrupted or the system may hang during POST. A BIOS update is required.		Fatal
A100	BIOS ACM Error		Major
A421	PCI component encountered a SERR error		Fatal
A5A0	PCI Express component encountered a PERR error		Minor
A5A1	PCI Express component encountered an SERR error		Fatal
A6A0	DXE Boot Services driver: Not enough memory available to shadow a Legacy Option ROM.	Disable OpRom at SETUP to save runtime memory.	Minor

## D.1 POST Error Beep Codes

The following table lists the POST error beep codes. Before system video initialization, the BIOS uses these beep codes to inform users on error conditions. The beep code is followed by a user-visible code on the POST progress LEDs.

**Table 54. POST Error Beep Codes**

Beeps	Error Message	POST Progress Code	Description
1 short	USB device action	N/A	Short beep sounded whenever USB device is discovered in POST or inserted or removed during runtime.
3 short	Memory error	Multiple	System halted because a fatal error related to the memory was detected.
3 long and 1 short	CPU mismatch error	E5, E6	System halted because a fatal error related to the CPU family/core/cache mismatch was detected.

The integrated BMC may generate beep codes upon detection of failure conditions. Beep codes are sounded each time the problem is discovered, such as on each power-up attempt, but are not sounded continuously. Codes that are common across all Intel server boards and systems that use same generation chipset are listed in the following table. Each digit in the code is represented by a sequence of beeps whose count is equal to the digit.

**Table 55. Integrated BMC Beep Codes**

Code	Reason for Beep	Associated Sensors
1-5-2-1	No CPUs installed or first CPU socket is empty	CPU Missing Sensor
1-5-2-4	MSID mismatch occurs if a processor is installed into a system board that has incompatible power capabilities.	MSID Mismatch Sensor
1-5-4-2	DC power unexpectedly lost (power good dropout) – Power unit sensors report power unit failure offset.	Power fault
1-5-4-4	Power control fault (power good assertion timeout).	Power unit – soft power control failure offset
1-5-1-2	VR Watchdog Timer sensor assertion	VR Watchdog Timer
1-5-1-4	The system does not power on or unexpectedly power off and a power supply unit (PSU) is present that is an incompatible model with one or more other PSUs in the system	PS Status

## D.2 Processor Initialization Error Summary

The following table describes mixed processor conditions and actions for all Intel server boards and Intel server systems designed with the Intel® Xeon® Scalable processor family architecture. The errors fall into one of the following categories:

- **Fatal:** If the system cannot boot, POST halts and delivers the following error message to the BIOS Setup Error Manager screen:

```
Unrecoverable fatal error found. System will not boot until the error is
resolved
```

Press <F2> to enter setup

When the <F2> key is pressed, the error message is displayed on the BIOS Setup Error Manager screen and an error is logged to the system event log (SEL) with the POST error code.

The “POST Error Pause” option setting in the BIOS Setup does not affect this error.

If the system is not able to boot, the system generates a beep code consisting of three long beeps and one short beep. The system cannot boot unless the error is resolved. The faulty component must be replaced.

The system status LED is set to a steady amber color for all fatal errors that are detected during processor initialization. A steady amber system status LED indicates that an unrecoverable system failure condition has occurred.

- **Major:** An error message is displayed to the Error Manager screen and an error is logged to the SEL. If the BIOS Setup option “Post Error Pause” is enabled, operator intervention is required to continue booting the system. If the BIOS Setup option “POST Error Pause” is disabled, the system continues to boot.
- **Minor:** An error message may be displayed to the screen or to the BIOS Setup Error Manager and the POST error code is logged to the SEL. The system continues booting in a degraded state. The user may want to replace the erroneous unit. The “POST Error Pause” option setting in the BIOS Setup does not affect this error.

**Table 56. Mixed Processor Configurations Error Summary**

Error	Severity	System Action when BIOS Detects the Error Condition
Processor family not identical	Fatal	<ul style="list-style-type: none"> <li>• Halts at POST code 0xE6.</li> <li>• Halts with three long beeps and one short beep.</li> <li>• Takes fatal error action (see above) and does not boot until the fault condition is remedied.</li> </ul>
Processor model not identical	Fatal	<ul style="list-style-type: none"> <li>• Logs the POST error code into the SEL.</li> <li>• Alerts the BMC to set the system status LED to steady amber.</li> <li>• Displays 0196: Processor model mismatch detected message in the error manager.</li> <li>• Takes fatal error action (see above) and does not boot until the fault condition is remedied.</li> </ul>
Processor cores/threads not identical	Fatal	<ul style="list-style-type: none"> <li>• Halts at POST code 0xE5.</li> <li>• Halts with three long beeps and one short beep.</li> <li>• Takes fatal error action (see above) and does not boot until the fault condition is remedied.</li> </ul>
Processor cache or home agent not identical	Fatal	<ul style="list-style-type: none"> <li>• Halts at POST code 0xE5.</li> <li>• Halts with three long beeps and one short beep.</li> <li>• Takes fatal error action (see above) and does not boot until the fault condition is remedied.</li> </ul>



Error	Severity	System Action when BIOS Detects the Error Condition
<b>Processor frequency (speed) not identical</b>	Fatal	<p>If the frequencies for all processors can be adjusted to be the same:</p> <ul style="list-style-type: none"> <li>• Adjusts all processor frequencies to the highest common frequency.</li> <li>• Does not generate an error – this is not an error condition.</li> <li>• Continues to boot the system successfully.</li> </ul> <p>If the frequencies for all processors cannot be adjusted to be the same:</p> <ul style="list-style-type: none"> <li>• Logs the POST error code into the SEL.</li> <li>• Alerts the BMC to set the system status LED to steady amber.</li> <li>• Does not disable the processor.</li> <li>• Displays 0197: Processor speeds unable to synchronize message in the error manager.</li> <li>• Takes fatal error action (see above) and does not boot until the fault condition is remedied</li> </ul>
<b>Processor Intel® UPI link frequencies not identical</b>	Fatal	<p>If the link frequencies for all Intel® Ultra Path Interconnect (Intel® UPI) links can be adjusted to be the same:</p> <ul style="list-style-type: none"> <li>• Adjusts all Intel® UPI interconnect link frequencies to highest common frequency.</li> <li>• Does not generate an error – this is not an error condition.</li> <li>• Continues to boot the system successfully.</li> </ul> <p>If the link frequencies for all Intel® UPI links cannot be adjusted to be the same:</p> <ul style="list-style-type: none"> <li>• Logs the POST error code into the SEL.</li> <li>• Alerts the BMC to set the system status LED to steady amber.</li> <li>• Does not disable the processor.</li> <li>• Displays 0195: Processor Intel® UPI link frequencies unable to synchronize message in the error manager.</li> <li>• Takes fatal error action (see above) and does not boot until the fault condition is remedied.</li> </ul>
<b>Processor microcode update failed</b>	Major	<ul style="list-style-type: none"> <li>• Logs the POST error code into the SEL.</li> <li>• Displays 816x: Processor 0x unable to apply microcode update message in the error manager or on the screen.</li> <li>• Takes major error action. The system may continue to boot in a degraded state, depending on the “POST Error Pause” setting in setup, or may halt with the POST error code in the error manager waiting for operator intervention.</li> </ul>
<b>Processor microcode update missing</b>	Minor	<ul style="list-style-type: none"> <li>• Logs the POST error code into the SEL.</li> <li>• Displays 818x: Processor 0x microcode update not found message in the error manager or on the screen.</li> <li>• The system continues to boot in a degraded state, regardless of the “POST Error Pause” setting in setup.</li> </ul>

## Appendix E. System Configuration Table for Thermal Compatibility

This appendix provides tables listing system configuration compatibility data based on various supported system operating thermal limits. Section E.1 identifies supported system configurations while the system is in “normal” operating mode, meaning that all systems fans are present, online, and operational. Section E.2 identifies supported system configurations while the system is in a “fan fail” mode, meaning more than one fan rotor in the same fan or different fans are in a failed state and fan redundancy is lost.

### E.1 Normal Operating Mode

For the tables in this section, a bullet (●) indicates full support without limitation. A cell with a number indicates conditional support. Refer to the following notes. A blank cell indicates that the configuration is not supported.

The following notes support criteria associated with specific configurations identified in the table and are identified by a reference number within the table. The notes apply to both Fan Normal mode discussed in this section and Fan Fail mode discussed in Section E2.

#### Notes:

##### Environment:

1. The 27°C configuration alone is limited to elevations of 900 m or less. Altitudes higher than 900 m need to be de-rated to ASHRAE Class 2 levels.
2. For ASHRAE Class 3 and Class 4 support, the following power supply margining is required to meet thermal specifications:
  - a. For dual power supply configurations, the power budget must fit within a single power supply rated load and be installed in a dual configuration, or
  - b. For single power supply configurations, the power budget must be sized with 30% margin to single power supply rated load.

##### CPU/DIMM:

3. Follow the processor Thermal Mechanical Specification and Design Guide (TMSDG), Rev 2.0 to evaluate CPU support matrix.
4. CPU support matrix and FSC DTS 2.0 are based on CPU base configuration of the TMSDG. If the end user change to other CPU configuration mode. It is possibility to see performance impact.
5. Processor and Memory throttling (over specification  $\leq 10$  °C) may occur that may impact system performance, but system is not shut down.
6. Processor and Memory heavy throttling (over specification  $> 10$  °C) may impact system performance, but system is not shut down.

**Key Component:**

7. PSU inlet temperature sensor will exceed 61 °C OTP, which impacts system power to limit system performance.
8. Use of the designated PCIe\* slot is limited to add-in cards that have airflow requirements of 100 LFM or less. See add-in card specifications for airflow requirements.
9. OCP V3 support the maximum 15W power consumption
10. M.2 drives are limited to operating system and boost only and may see performance impact under heavy workload.
11. Intel NVMe drives used for thermal testing.
12. If the end user installs any SSD in the system w/o NVMe sensor temp reading in Integrated BMC Web Console, the end user should manually turn fan profile to Performance mode in BIOS.
13. See [Chapter 6](#) for thermal limitations.

**System:**

14. R1XXX only support LP PCIe card
15. R1212 can support 205W processors with 1U POR HS at normal fan stats with limitation.
16. R1204 can support 270W processors with 1U EVAC HS at normal fan stats.
17. Nvidia\* T4 only support in R1204 at 27 °C
18. If system detect Nvidia T4, the fan profile will auto jump to profile #7 (CCB#3177)
19. System cooling capability testing was carried out in environmental lab controlled conditions according to the ASHRAE standard.
20. Performance depends on data center environmental temperature and relative humidity levels controls provided by end user.
21. It is the responsibility of the system integrator to both consider the thermal configuration matrix and power budget tool documents to arrange end use configuration

**Fan Failure:**

22. To support system fan redundancy, the system must be configured with two power supplies to maintain sufficient cooling. Concurrent system and power supply fan failures are not supported.
23. Fan failure support optimization frequency. DIMM/CPU may appear throttling but system is not shut down.
24. In fan fail mode, Intel® OCP Modules are only supported in the specified base system model configured.

**Table 57. Thermal Configuration Matrix – Normal Operating Mode (R1204CYP and R1212CYP)**

HTA configuration matrix for fan normal "•"= Full Support without limitation; "5, 6, 7"(Cell with number=)Conditional support with limitation; " "(Blank)=Not support;			Base System SKUs: R1204CYP (See Notes 14, 16–21)							Base System SKUs: R1212CYP (See Notes 14, 15, 19–21)										
ASHRAE (See Notes 1, 2)	Classifications					275 °C	A1	A2	A3	A4				275 °C	A1	A2	A3	A4		
	Maximum Ambient		15 °C	20 °C	25 °C	27 °C(1)	32 °C	35 °C	40 °C	45 °C	15 °C	20 °C	25 °C	27 °C(1)	32 °C	35 °C	40 °C	45 °C		
PSU (See Note 7)	1600W		•	•	•	•	•	•	7	7	•	•	•	•	•	•	7	7		
	1300W		•	•	•	•	•	•	7	7	•	•	•	•	•	•	7	7		
3 <sup>rd</sup> Gen Intel® Xeon® Scalable processors (See Notes 3, 4, 5, 6)	270W	40 Core, Intel® Xeon® Platinum 8380	•	•	•	•	•	•	5	5										
		38 Core, Intel® Xeon® Platinum 8368	•	•	•	•	•	•	5	5										
		38 Core, Intel® Xeon® Platinum 8368Q	5	5	6	6	6													
	265W	36 Core, Intel® Xeon® Platinum 8362	•	•	•	•	•	•	5	6										
		250W	36 Core, Intel® Xeon® Platinum 8360Y	•	•	•	•	•	•	5	5									
		32 Core, Intel® Xeon® Platinum 8358	•	•	•	•	•	•	5	5										
	240W	32 Core, Intel® Xeon® Platinum 8358P, Optimized CSP SKU	•	•	•	•	•	•	5	5										
		235W	32 Core, Intel® Xeon® Gold 6348	•	•	•	•	•	•	5	5									
	XCC	205W	32 Core, Intel® Xeon® Platinum 8352S	•	•	•	•	•	•	•	5	•	•	•	•	5	5	5	6	
			32 Core, Intel® Xeon® Platinum 8352Y	•	•	•	•	•	•	•	5	•	•	•	•	5	5	5	6	
			18 Core, Intel® Xeon® Gold 6354	•	•	•	•	•	•	•	5	5	•	•	5	5	5	6	6	6
			16 Core, Intel® Xeon® Gold 6346	•	•	•	•	•	•	•	5	5	•	•	5	5	5	6	6	6
			32 Core, Intel® Xeon® Gold 6338	•	•	•	•	•	•	•	5	5	•	•	•	•	5	5	5	6
			28 Core, Intel® Xeon® Gold 6330	•	•	•	•	•	•	•	5	5	•	•	•	•	5	5	5	6
	195W	36 Core, Intel® Xeon® Platinum 8352V, Optimized CSP SKU	•	•	•	•	•	•	•	5	•	•	•	•	5	5	5	6		
		185W	32 Core, Intel® Xeon® Gold 6338N, Optimized NFV SKU	•	•	•	•	•	•	•	•	•	•	•	•	•	•	5	5	

Intel® Server System M50CYP1UR Family Technical Product Specification

HTA configuration matrix for fan normal "•"= Full Support without limitation; "5, 6, 7"(Cell with number=)Conditional support with limitation; " "(Blank)=Not support;				Base System SKUs: R1204CYP (See Notes 14, 16–21)							Base System SKUs: R1212CYP (See Notes 14, 15, 19–21)											
ASHRAE (See Notes 1, 2)	Classifications						275 °C	A1	A2	A3	A4				275 °C	A1	A2	A3	A4			
	Maximum Ambient			15 °C	20 °C	25 °C	27 °C(1)	32 °C	35 °C	40 °C	45 °C	15 °C	20 °C	25 °C	27 °C(1)	32 °C	35 °C	40 °C	45 °C			
HCC			32 Core, Intel® Xeon® Gold 6338M, Optimized Media SKU	•	•	•	•	•	•	•	5	•	•	•	•	5	5	5	6			
		165W	28 Core, Intel® Xeon® Gold 6330N, Optimized NFV SKU	•	•	•	•	•	•	•	•	•	•	•	•	•	•	•	•	•	5	
		230W		24 Core, Intel® Xeon® Gold 6342	•	•	•	•	•	•	5	5										
		185W		24 Core, Intel® Xeon® Gold 6336Y	•	•	•	•	•	•	•	5	5	•	•	•	•	5	5	5	6	
				16 Core, Intel® Xeon® Gold 6326	•	•	•	•	•	•	•	5	5	•	•	•	•	5	5	5	6	
				26 Core, Intel® Xeon® Gold 5315	•	•	•	•	•	•	•	5	5	•	•	•	•	5	5	5	6	
		165W		8 Core, Intel® Xeon® Gold 6334	•	•	•	•	•	•	•	5	5	•	•	5	5	5	6	6		
				24 Core, Intel® Xeon® Gold 5318S	•	•	•	•	•	•	•	•	•	•	•	•	•	•	•	•	•	5
				24 Core, Intel® Xeon® Gold 5318Y	•	•	•	•	•	•	•	•	•	•	•	•	•	•	•	•	•	5
				24 Core, Intel® Xeon® Gold 5338T, 10-year use + NEBS-friendly	•	•	•	•	•	•	•	5	5	•	•	•	•	5	5	6	6	
		150W		12 Core, Intel® Xeon® Gold 5317	•	•	•	•	•	•	•	•	•	•	•	•	•	•	•	•	•	5
				20 Core, Intel® Xeon® Silver 4316	•	•	•	•	•	•	•	•	•	•	•	•	•	•	•	•	•	5
				24 Core, Intel® Xeon® Gold 5318N, Optimized NFV SKU	•	•	•	•	•	•	•	•	•	•	•	•	•	•	•	•	•	5
				20 Core, Intel® Xeon® Gold 5320T, 10-year use + NEBS-friendly	•	•	•	•	•	•	•	5	5	•	•	•	•	5	5	6	6	
		140W		8 Core, Intel® Xeon® Gold 5315Y	•	•	•	•	•	•	•	•	•	•	•	•	•	•	•	•	5	
		135W		16 Core, Intel® Xeon® Silver 4314	•	•	•	•	•	•	•	•	•	•	•	•	•	•	•	•	•	
		120W		12 Core, Intel® Xeon® Silver 4310	•	•	•	•	•	•	•	•	•	•	•	•	•	•	•	•	•	

Intel® Server System M50CYP1UR Family Technical Product Specification

HTA configuration matrix for fan normal "●"= Full Support without limitation; "5, 6, 7"(Cell with number=)Conditional support with limitation; " "(Blank)=Not support;				Base System SKUs: R1204CYP (See Notes 14, 16–21)								Base System SKUs: R1212CYP (See Notes 14, 15, 19–21)							
ASHRAE (See Notes 1, 2)	Classifications						275 °C	A1	A2	A3	A4				275 °C	A1	A2	A3	A4
	Maximum Ambient			15 °C	20 °C	25 °C	27 °C(1)	32 °C	35 °C	40 °C	45 °C	15 °C	20 °C	25 °C	27 °C(1)	32 °C	35 °C	40 °C	45 °C
	105W	8 Core, Intel® Xeon® Silver 4309Y		●	●	●	●	●	●	●	●	●	●	●	●	●	●	●	●
		10 Core, Intel® Xeon® Silver 4310T, 10-year use + NEBS-friendly		●	●	●	●	●	●	●	●	●	●	●	●	●	●	●	●
Memory Type (See Notes 3, 4, 5, 6)	LRDIMM QRx4 (16Gb) - 2DPC 13W			●	●	●	●	●	●	●	5	●	●	●	●	●	●	5	5
	LR-DIMM 8Rx4 - 2DPC 16W			●	●	●	●	●	●	5	5	●	●	●	●	5	5	5	6
	LRDIMM QRx4 - 2DPC 12W			●	●	●	●	●	●	●	●	●	●	●	●	●	●	●	5
	RDIMM-DRx4 - 2DPC 7W			●	●	●	●	●	●	●	●	●	●	●	●	●	●	●	●
	RDIMM-DRx8 - 2DPC 4W			●	●	●	●	●	●	●	●	●	●	●	●	●	●	●	●
	RDIMM SRx4 - 2DPC 5W			●	●	●	●	●	●	●	●	●	●	●	●	●	●	●	●
Intel® Optane™ PMem 200 series (See Notes 3, 4, 5, 6)	128 Gb (TDP=12W)			●	●	●	●	●	●	5	5	●	●	●	●	●	●	5	
	256 GB (TDP=15W)			●	●	●	●	●	●	5	5	●	●	●	●	●	●	5	
	512 GB (TDP=15W)			●	●	●	●	●	●	5	5	●	●	●	●	●	●	5	
Add-in Cards (See Note 8)	Riser #1 - 100LFM			●	●	●	●	●	●	●	●	●	●	●	●	●	●	●	●
	Riser #1 - 200LFM			●	●	●	●	●	●	●	●	●	●	●	●	●	●	●	●
	Riser #1 - 300LFM			●	●	●	●	●	●	●	●	●	●	●	●	●	●	●	●
	Interposer slot - 1U riser - 100LFM			●	●	●	●	●	●	●	●	●	●	●	●	●	●	●	●
	Interposer slot - 1U riser - 200LFM			●	●	●	●	●	●	●	●	●	●	●	●	●	●	●	●
	Interposer slot - 1U riser - 300LFM			●	●	●	●	●	●	●	●	●	●	●	●	●	●	●	●
	Riser #2 - 100LFM			●	●	●	●	●	●	●	●	●	●	●	●	●	●	●	●
	Riser #2 - 200LFM			●	●	●	●	●	●	●	●	●	●	●	●	●	●	●	●
SAS and I/O Modules	RAID Expander RES3TV360			●	●	●	●	●	●	●	●	●	●	●	●	●	●	●	
	Integrated RAID module RMSP3AD160			●	●	●	●	●	●	●	●	●	●	●	●	●	●	●	●
Battery Backup	BBU (rated to 45 °C)			●	●	●	●	●	●	●	●	●	●	●	●	●	●	●	
2.5" PCIe NVMe SSD (See Notes 11, 12)	P4510_1TB / 25W			●	●	●	●	●	●	●	●	●	●	●	●	●	●	●	
	P4326_15.4TB / 20W			●	●	●	●	●	●	●	●	●	●	●	●	●	●	●	
	P4610_6.4TB / 15W			●	●	●	●	●	●	●	●	●	●	●	●	●	●	●	
OCP V3 (See Note 9)	OCP 15W W/class-2QSFP			●	●	●	●	●	●	●	●	●	●	●	●	●	●	●	
PCIe Card (See Note 17)	Tesla* T4 w/ 24GB memory			●	●	●	●												



## E.2 Fan Fail Mode

For the table in this section, a bullet (●) indicates full support without limitation. A cell with a number indicates conditional support. Refer to the notes above. A blank cell indicates that the configuration is not supported.

See the notes in Section E1. The notes support criteria associated with specific configurations identified in the table and are identified by a reference number within the table.

**Table 58. Thermal Configuration Matrix – Fan Fail Mode (R1204CYP and R1212CYP)**

HTA configuration matrix for fan failure "●"= Full Support without limitation; "5, 6, 7"(Cell with number=)Conditional support with limitation; "(Blank)=Not support; (See Notes 22 to 23)			Base System SKUs: R1204CYP (See Notes 14, 19 to 21)		Base System SKUs: R1212CYP (See Notes 14, 19 to 21)			
ASHRAE (See Notes 1, 2)	Classifications		27 °C	A2	27 °C	A2		
	Maximum Ambient		27 °C(1)	35 °C	27 °C(1)	35 °C		
PSU (See Note 7)	1600W		●	7	●	7		
	1300W		●	7	●	7		
3 <sup>rd</sup> Gen Intel® Xeon® Scalable processors (See Notes 3, 4, 5, 6)	270W	40 Core, Intel® Xeon® Platinum 8380	●	5				
		38 Core, Intel® Xeon® Platinum 8368	●	5				
		38 Core, Intel® Xeon® Platinum 8368Q	6					
	265W	36 Core, Intel® Xeon® Platinum 8362		●	5			
		250W	36 Core, Intel® Xeon® Platinum 8360Y	●	5			
	32 Core, Intel® Xeon® Platinum 8358		●	5				
	240W	32 Core, Intel® Xeon® Platinum 8358P, Optimized CSP SKU		●	5			
	235W	32 Core, Intel® Xeon® Gold 6348		●	5			
	XCC	205W	32 Core, Intel® Xeon® Platinum 8352S	●	●	5	6	
			32 Core, Intel® Xeon® Platinum 8352Y	●	●	5	6	
			18 Core, Intel® Xeon® Gold 6354	●	5	6	6	
			16 Core, Intel® Xeon® Gold 6346	●	5	6	6	
			32 Core, Intel® Xeon® Gold 6338	●	●	5	6	
			28 Core, Intel® Xeon® Gold 6330	●	●	5	6	
		195W	36 Core, Intel® Xeon® Platinum 8352V, Optimized CSP SKU		●	●	5	6
		185W	32 Core, Intel® Xeon® Gold 6338N, Optimized NFV SKU		●	●	●	5
	32 Core, Intel® Xeon® Gold 6338M, Optimized Media SKU		●	●	5	6		
	165W	28 Core, Intel® Xeon® Gold 6330N, Optimized NFV SKU		●	●	●	●	
	HCC	230W	24 Core, Intel® Xeon® Gold 6342		●	5		
			24 Core, Intel® Xeon® Gold 6336Y		●	●	5	6
16 Core, Intel® Xeon® Gold 6326			●	●	5	6		

Intel® Server System M50CYP1UR Family Technical Product Specification

HTA configuration matrix for fan failure "●"= Full Support without limitation; "5, 6, 7"(Cell with number=)Conditional support with limitation; "(Blank)=Not support; (See Notes 22 to 23)				Base System SKUs: R1204CYP (See Notes 14, 19 to 21)		Base System SKUs: R1212CYP (See Notes 14, 19 to 21)	
ASHRAE (See Notes 1, 2)	Classifications			27 °C	A2	27 °C	A2
	Maximum Ambient			27 °C(1)	35 °C	27 °C(1)	35 °C
	165W		26 Core, Intel® Xeon® Gold 5315	●	●	5	6
			8 Core, Intel® Xeon® Gold 6334	●	5	5	6
			24 Core, Intel® Xeon® Gold 5318S	●	●	●	●
			24 Core, Intel® Xeon® Gold 5318Y	●	●	●	●
			24 Core, Intel® Xeon® Gold 5338T, 10-year use + NEBS-friendly	●	5	5	6
	150W		12 Core, Intel® Xeon® Gold 5317	●	●	●	●
			20 Core, Intel® Xeon® Silver 4316	●	●	●	●
			24 Core, Intel® Xeon® Gold 5318N, Optimized NFV SKU	●	●	●	●
		20 Core, Intel® Xeon® Gold 5320T, 10-year use + NEBS-friendly	●	●	5	6	
	140W		8 Core, Intel® Xeon® Gold 5315Y	●	●	●	●
	135W		16 Core, Intel® Xeon® Silver 4314	●	●	●	●
	120W		12 Core, Intel® Xeon® Silver 4310	●	●	●	●
	105W		8 Core, Intel® Xeon® Silver 4309Y	●	●	●	●
			10 Core, Intel® Xeon® Silver 4310T, 10-year use + NEBS-friendly	●	●	●	●
Memory Type (See Notes 3, 4, 5, 6)	LRDIMM QRx4 (16Gb) - 2DPC 13W			●	5	5	5
	LR-DIMM 8Rx4 - 2DPC 16W			●	5	5	5
	LRDIMM QRx4 - 2DPC 12W			●	●	●	●
	RDIMM-DRx4 - 2DPC 7W			●	●	●	●
	RDIMM-DRx8 - 2DPC 4W			●	●	●	●
	RDIMM SRx4 - 2DPC 5W			●	●	●	●
	RDIMM SRx8 -2DPC 3W			●	●	●	●
Intel® Optane™ PMem 200 Series (See Notes 3, 4, 5, 6)	128 Gb (TDP=12W)			●	●	●	●
	256 GB (TDP=15W)			●	5	●	5
	512 GB (TDP=15W)			●	5	●	5
Add-in Cards (See Note 8)	Riser #1 - 100LFM			●	●	●	●
	Riser #1 - 200LFM			●	●	●	●
	Riser #1 - 300LFM			●	●	●	●
	Interposer slot - 1U riser - 100LFM			●	●	●	●
	Interposer slot - 1U riser - 200LFM			●	●	●	●
	Interposer slot - 1U riser - 300LFM			●	●	●	●
	Riser #2 - 100LFM			●	●	●	●
	Riser #2 - 200LFM			●	●	●	●
	Riser #2 - 300LFM			●	●	●	●
RAID Expander RES3TV360			●	●	●	●	

Intel® Server System M50CYP1UR Family Technical Product Specification

HTA configuration matrix for fan failure "●"= Full Support without limitation; "5, 6, 7"(Cell with number=)Conditional support with limitation; " "(Blank)=Not support; (See Notes 22 to 23)		Base System SKUs: R1204CYP (See Notes 14, 19 to 21)		Base System SKUs: R1212CYP (See Notes 14, 19 to 21)	
ASHRAE (See Notes 1, 2)	Classifications	27 °C	A2	27 °C	A2
	Maximum Ambient	27 °C(1)	35 °C	27 °C(1)	35 °C
SAS and I/O Modules	Integrated RAID module RMSP3AD160	●	●	●	●
Battery Backup	BBU (rated to 45 °C)	●	●	●	●
2.5" PCIe NVMe SSD (See Notes 11, 12)	P4510_1TB / 25W	●	●	●	●
	P4326_15.4TB / 20W	●	●	●	●
	P4610_6.4TB / 15W	●	●	●	●
OCP V3 (See Note 9)	OCP 15W W/class-2QSFP	●	●	●	●
PCIe Card (See Note 17)	Tesla T4 w/ 24GB memory				

## Appendix F. System Sensors

The following figure provides the location of the sensors on the Intel® Server System M50CYP1UR. The following table provides a list of the sensors.

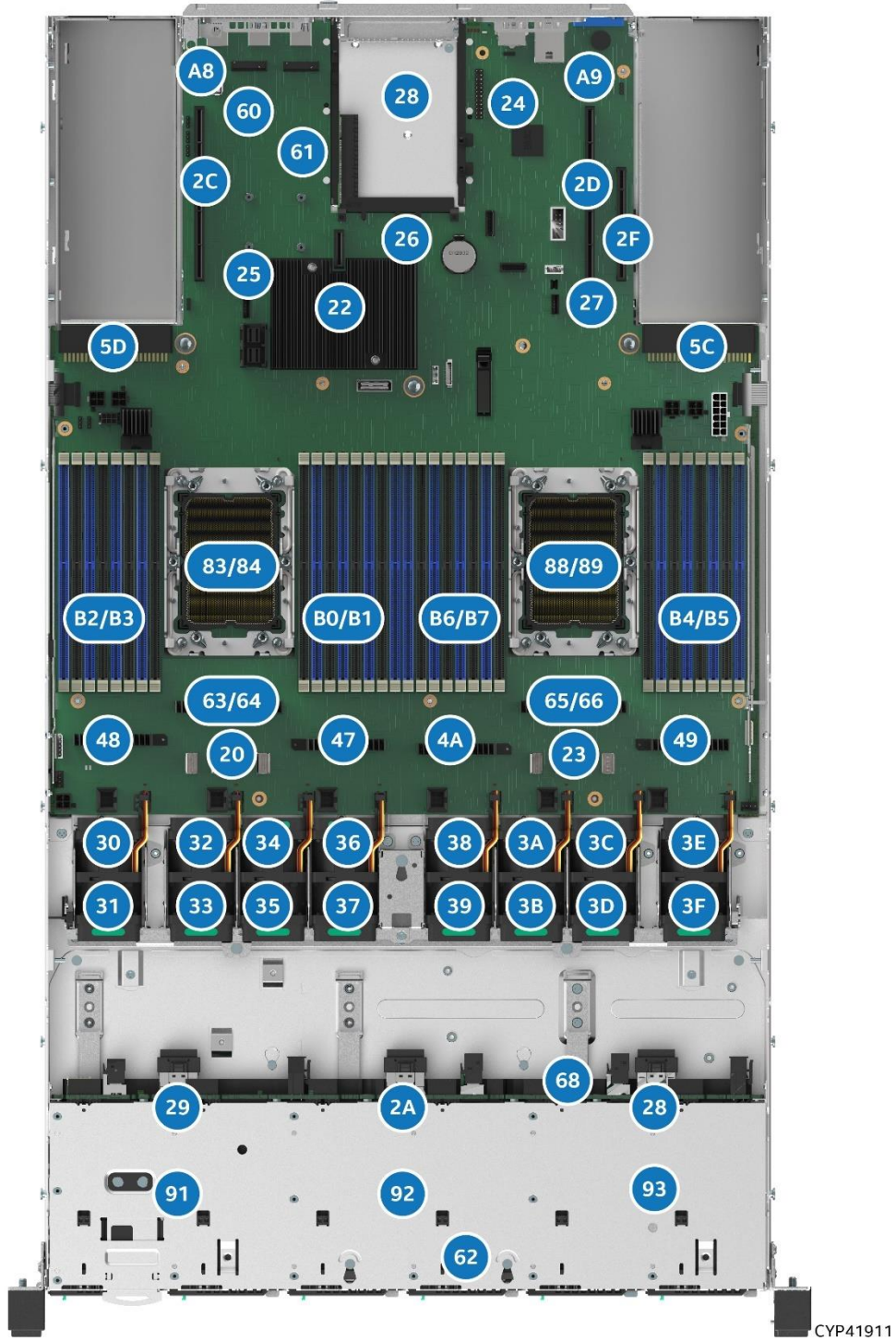

**Note:** The numbers in the figure are hexadecimal numbers.

**Figure 105. System Sensor Map**

**Table 59. System Sensors**

Sensor #	Sensor Name
62h	HDD Aggregate Margin
91h	NVMe 1 Therm Mgn
92h	NVMe 2 Therm Mgn
93h	NVMe 3 Therm Mgn
29h	Hot-swap Backplane 1 Temperature (HSBP 1 Temp)
2Ah	Hot-swap Backplane 2 Temperature (HSBP 2 Temp)
2Bh	Hot-swap Backplane 3 Temperature (HSBP 3 Temp)
68h	SAS Module Temperature (SAS Mod Temp)
69h	Left Swch Temp
6Ah	Right Swch Temp
30h	Fan Tachometer Sensors2 (System Fan 1)
31h	Fan Tachometer Sensors2 (System Fan 1B)
32h	Fan Tachometer Sensors2 (System Fan 2)
33h	Fan Tachometer Sensors2 (System Fan 2B)
34h	Fan Tachometer Sensors2 (System Fan 3)
35h	Fan Tachometer Sensors2 (System Fan 3B)
36h	Fan Tachometer Sensors2 (System Fan 4)
37h	Fan Tachometer Sensors2 (System Fan 4B)
38h	Fan Tachometer Sensors2 (System Fan 5)
39h	Fan Tachometer Sensors2 (System Fan 5B)
3Ah	Fan Tachometer Sensors2 (System Fan 6)
3Bh	Fan Tachometer Sensors2 (System Fan 6B)
3Ch	Fan Tachometer Sensors2 (Processor 1 Fan)
3Dh	Fan Tachometer Sensors2 (Processor 2 Fan)
3Eh	Fan Tachometer Sensors2 (Rear Fan A)

Sensor #	Sensor Name
3Fh	Fan Tachometer Sensors2 (Rear Fan B)
47h	P0 DIMM VR Mgn 1
48h	P0 DIMM VR Mgn 2
49h	P1 DIMM VR Mgn 1
4Ah	P1 DIMM VR Mgn 2
20h	Baseboard Temperature 1 (BB P1 VR Temp)
23h	Baseboard Temperature 2 (BB P2 VR Temp)
63h	P0 VR Ctrl Temp
64h	P0 VR Mgn
65h	P1 VR Ctrl Temp
66h	P1 VR Mgn
B0h	Processor 1 DIMM Aggregate Thermal Margin 1 (DIMM Thrm Mrgn 1)
B1h	Processor 1 DIMM Aggregate Thermal Margin 2 (DIMM Thrm Mrgn 2)
B2h	Processor 1 DIMM Aggregate Thermal Margin 3 (DIMM Thrm Mrgn 3)
B3h	Processor 1 DIMM Aggregate Thermal Margin 4 (DIMM Thrm Mrgn 4)
B4h	Processor 2 DIMM Aggregate Thermal Margin 1 (DIMM Thrm Mrgn 5)
B5h	Processor 2 DIMM Aggregate Thermal Margin 2 (DIMM Thrm Mrgn 6)
B6h	Processor 2 DIMM Aggregate Thermal Margin 3 (DIMM Thrm Mrgn 7)
B7h	Processor 2 DIMM Aggregate Thermal Margin 4 (DIMM Thrm Mrgn 8)
83h	P0 D1 DTS Th Mgn
84h	P0 D2 DTS Th Mgn
88h	P1 D1 DTS Th Mgn
89h	P1 D2 DTS Th Mgn
5Ch	Power Supply 1 Temperature (PS1 Temperature)
5Dh	Power Supply 2 Temperature (PS2 Temperature)
A8h	PHI 1 Thermal Margin (PHI 1 Margin)
A9h	PHI 2 Thermal Margin (PHI 2 Margin)
2Ch	PCI Riser 1 Temperature (Riser 1 Temp)



Sensor #	Sensor Name
60h	M2 Left Margin
61h	M2 Right Margin
22h	SSB Temperature (SSB Temp)
24h	Baseboard Temperature 3 (BB BMC Temp)
25h	Baseboard Temperature 3 (BB M.2 Temp)
26h	Baseboard Temperature 5 (BB OCP Temp)
27h	Baseboard Temperature 4 (BB Rt Rear Temp)
28h	OCP Module Temperature (OCP Mod Temp)
2Dh	PCI Riser 2 Temperature (Riser 2 Temp)
2Fh	PCI Riser 3 Temperature (Riser 3 Temp)

## Appendix G. Statement of Volatility

The tables in this section are used to identify the volatile and non-volatile memory components for system boards used within the Intel® Server System M50CYP1UR family.

The tables provide the following data for each identified component.

- **Component Type:** Three types of components are on the server board assembly:
  - **Non-volatile:** Non-volatile memory is persistent and is not cleared when power is removed from the system. Non-volatile memory must be erased to clear data. The exact method of clearing these areas varies by the specific component. Some areas are required for normal operation of the server, and clearing these areas may render the server board inoperable
  - **Volatile:** Volatile memory is cleared automatically when power is removed from the system.
  - **Battery powered RAM:** Battery powered RAM is similar to volatile memory but is powered by a battery on the server board. Data in battery powered RAM is persistent until the battery is removed from the server board.
- **Size:** Size of each component in bits, kilobits (Kbits), megabits (Mbits), bytes, kilobytes (KB), or megabytes (MB).
- **Board Location:** Board location is the physical location of each component corresponding to information on the server board silkscreen.
- **User Data:** The flash components on the server boards do not store user data from the operating system. No operating system level data is retained in any listed components after AC power is removed. The persistence of information written to each component is determined by its type as described in the table.

Each component stores data specific to its function. Some components may contain passwords that provide access to that device's configuration or functionality. These passwords are specific to the device and are unique and unrelated to operating system passwords. The specific components that may contain password data are:

- **BIOS:** The server board BIOS provides the capability to prevent unauthorized users from configuring BIOS settings when a BIOS password is set. This password is stored in BIOS flash and is only used to set BIOS configuration access restrictions.
- **BMC:** The server boards support an Intelligent Platform Management Interface (IPMI) 2.0 conformant baseboard management controller (BMC). The BMC provides health monitoring, alerting and remote power control capabilities for the Intel server board. The BMC does not have access to operating system level data.

The BMC supports the capability for remote software to connect over the network and perform health monitoring and power control. This access can be configured to require authentication by a password. If configured, the BMC maintains user passwords to control this access. These passwords are stored in the BMC flash.

The Intel® Server System M50CYP1UR family includes several components that can be used to store data. A list of those components is included in the following table.

**Table 60. Server Board Components**

Component Type	Size	Board Location	User Data	Name
Non-Volatile	64 MB	U4	No	BIOS Flash
Non-Volatile	128 MB	U3	No	BMC Flash
Non-Volatile	UFM 1,376 Kb M9K Memory 378 Kb	U39	No	FPGA
Volatile	4Gb	U21	No	BMC SDRAM

System boards in the Intel® Server System M50CYP1UR family may include components used to store data. The following tables provide a list of components associated with specific system boards supported by this family. For server board components, see the table above.

**Table 61. System Board Components**

Component Type	Size	Board Location	User Data	Name
Non-Volatile	256 B	U3	No	PCIe NVMe Riser Card FRU
Non-Volatile	256 B	U6	No	Riser Card (iPC – CYP1URISER2STD) on Riser Slot #2 FRU
Non-Volatile	256 B	U101	No	Riser Card (iPC – CYP1URISER1STD) on Riser Slot #1 FRU
Non-Volatile	256 B	U5	No	PCIe* NVMe* Riser Card (iPC – CYP1URISER2KIT) on Riser Slot #2 FRU
Non-Volatile	256 KB	U8	No	PCIe* NVMe* Riser Card (iPC – CYP1URISER2KIT) on Riser Slot #2 EEPROM
Non-Volatile	256 B	U9	No	PCIe* NVMe* Riser Card (iPC – CYPRISER3RTM) on Riser Slot #3 FRU
Non-Volatile	256 KB	U2	No	PCIe* NVMe* Riser Card (iPC – CYPRISER3RTM) on Riser Slot #3 EEPROM

System boards in Intel® server chassis contain components used to store data. A list of components for the system boards in the chassis is included in the following table. For server board components, see the tables above.

**Table 62. Server Chassis Components**

Component Type	Size	Board Location	User Data	Name
Non-Volatile	UFM 1,376 Kb M9K Memory 378 Kb	U2	No	FPGA Flash in 4 x 2.5" HSBP
Non-Volatile	256 B	U12	No	4 x 2.5" HSBP FRU
Non-Volatile	UFM 1,376 Kb M9K Memory 378 Kb	U1	No	FPGA Flash in 12 x 2.5" HSBP
Non-Volatile	256 B	U12	No	12 x 2.5" HSBP FRU

## Appendix H. Product Regulatory Compliance

This product has been evaluated and certified as Information Technology Equipment (ITE), which may be installed in offices, schools, computer rooms, and similar commercial type locations. The suitability of this product for other product certification categories and/or environments (such as: medical, industrial, telecommunications, NEBS, residential, alarm systems, test equipment, and so on), other than an ITE application, will require further evaluation and may require additional regulatory approvals.

Intel has verified that all L3, L6, and L9 server products<sup>1</sup> **as configured and sold by Intel** to its customers comply with the requirements for all regulatory certifications defined in the following table. **It is the Intel customer's responsibility to ensure their final server system configurations are tested and certified to meet the regulatory requirements for the countries to which they plan to ship and or deploy server systems into.**

	Intel® Server Board M50CYP2SB Family	Intel® Server System M50CYP2UR Family	Notes
	"Coyote Pass"	2U "Coyote Pass"	Intel Project Code Name
	L3 Board	L6/L9 System	Product integration level
	M50CYP	M500002UR M500001UR	Product family identified on certification
Regulatory Certification			
RCM DoC Australia & New Zealand	✓	✓	
CB Certification & Report (International - report to include all CB country national deviations)	✓	✓	
China CCC Certification	○	○	Out of CCC Scope
CU Certification (Russia/Belarus/Kazakhstan)	○	✓	
Europe CE Declaration of Conformity	✓	✓	
FCC Part 15 Emissions Verification (USA & Canada)	✓	✓	
Germany GS Certification	○	✓	
India BIS Certification	○	●	Only L9 at MSL
International Compliance – CISPR32 & CISPR24	✓	✓	
Japan VCCI Certification	○	✓	
Korea KC Certification	✓	✓	
Mexico Certification	○	✓	
NRTL Certification (USA&Canada)	✓	✓	
South Africa Certification	○	✓	
Taiwan BSMI Certification	✓	✓	
Ukraine Certification	○	✓	

### Table Key

Not Tested / Not Certified	○
Tested / Certified – Limited OEM SKUs only	●
Testing / Certification (Planned)	(Date)
Tested / Certified	✓

<sup>1</sup> An L9 system configuration is a power-on ready server system with NO operating system installed.

An L6 system configuration requires additional components to be installed in order to make it power-on ready. L3 are component building block options that require integration into a chassis to create a functional server system.

## EU Directive 2019/424 (Lot 9)

Beginning on March 1, 2020, an additional component of the European Union (EU) regulatory CE marking scheme, identified as EU Directive 2019/424 (Lot 9), will go into effect. After this date, all new server systems shipped into or deployed within the EU must meet the full CE marking requirements including those defined by the additional EU Lot 9 regulations.

Intel has verified that all L3, L6, and L9 server products<sup>2</sup> **as configured and sold by Intel** to its customers comply with the full CE regulatory requirements for the given product type, including those defined by EU Lot 9. **It is the Intel customer's responsibility to ensure their final server system configurations are SPEC® SERT™ tested and meet the new CE regulatory requirements.**

Visit the following website for additional EU Directive 2019/424 (Lot9) information:

<https://eur-lex.europa.eu/legal-content/EN/TXT/?uri=CELEX:32019R0424>

In compliance with the EU Directive 2019/424 (Lot 9) materials efficiency requirements, Intel makes available all necessary product collaterals as identified below:

- **System Disassembly Instructions**
  - *Intel® Server System M50CYP1UR Integration and Service Guide*  
<https://www.intel.com/content/www/us/en/support/products/200321.html>
- **Product Specifications**
  - *Intel® Server System M50CYP1UR Family Technical Product Specification* (This document)  
<https://www.intel.com/content/www/us/en/support/products/200321.html>
  - *Intel® Server Board M50CYP2SB Family Technical Product Specification*  
<https://www.intel.com/content/www/us/en/support/products/200321.html>
- **System BIOS/Firmware and Security Updates – Intel® Server Board M50CYP2SB family**
  - System Update Package (SUP) – uEFI only  
<http://downloadcenter.intel.com>
- **Intel® Solid State Drive (SSD) Secure Data Deletion and Firmware Updates**
  - Note: for system configurations that may be configured with an Intel SSD
  - Intel® Solid State Drive Toolbox  
<https://downloadcenter.intel.com/product/35125/Memory-and-Storage>
- **Intel® RAID Controller Firmware Updates and other support collaterals**
  - Note: for system configurations that may be configured with an Intel® RAID Controller  
<https://www.intel.com/content/www/us/en/support/products/43732/server-products/raid-products.html>

---

<sup>2</sup> An L9 system configuration is a power-on ready server system with NO operating system installed.

An L6 system configuration requires additional components to be installed in order to make it power-on ready. L3 are component building block options that require integration into a chassis to create a functional server system

<b>Product Info.</b>																
Product Type	Server															
Manufacturer Name	Intel Corporation															
Registered trade name and address	Intel 2200 Mission College Blvd, Santa Clara, CA 95054-1594, USA															
Product model number and model numbers for low end performance and high-end performance configure if applicable	M500001UR															
Year Of Launch	2021															
PSU efficiency at 10%, 20%, 50% and 100% of rated output power	AXX1300TCRPS(PSSF132202A) - 1300W AC Titanium AXX1600TCRPS (PSSF162205A) – 1600W AC Titanium <table border="1"> <thead> <tr> <th>Model</th> <th>10%</th> <th>20%</th> <th>50%</th> <th>100%</th> </tr> </thead> <tbody> <tr> <td>AXX1300T CRPS</td> <td>92.77%</td> <td>95.47%</td> <td>96.01%</td> <td>94.21%</td> </tr> <tr> <td>AXX1600T CRPS</td> <td>90.95%</td> <td>94.57%</td> <td>96.25%</td> <td>95.15%</td> </tr> </tbody> </table>	Model	10%	20%	50%	100%	AXX1300T CRPS	92.77%	95.47%	96.01%	94.21%	AXX1600T CRPS	90.95%	94.57%	96.25%	95.15%
Model	10%	20%	50%	100%												
AXX1300T CRPS	92.77%	95.47%	96.01%	94.21%												
AXX1600T CRPS	90.95%	94.57%	96.25%	95.15%												
PSU factor at 50% of rated load level	>0.99 (PSSF132202A) 0.99 (PSSF162205A)															
PSU Rated Power Output (Server Only)	1300W (PSSF132202A) 1600W (PSSF162205A)															
Idle state power (Server only) (Watts)	Refer to the following table															
List of all components for additional idle power allowances (server only)	Refer to the following table															
Maximum power (Server only)	Refer to the following table															
Declared operating condition class	Class A2 – Continuous Operation. 10°C to 35°C with the maximum rate of change not to exceed 10°C per hour.															
Idle State Power (watts) at the higher boundary temp (Server Only)	Refer to the following table															
the active state efficiency and the performance in active state of the server (server only)	Refer to the following table															
Information on the secure data deletion functionality	Refer to the following table															
for blade server, a list of recommended combinations with compatible chassis (Server only)	Not Applicable															
If Product Model Is Part Of A Server Product Family, a list of all model configurations that are represented by the model shall be supplied (Server only)	Not Applicable															



## Energy Efficiency Data of M500001U – 1 (Single) Processor Installed Configurations

Configuration			1 CPU Low-end Config.	1 CPU High-end Config.
Details	Chassis	Model	M500001UR	
	Node/MB	Quantity	1	1
		Model	M50CYP	M50CYP
	CPU	Quantity	1 per Node	1 per Node
		Model	Gold 6346	Platinum 8380
	Memory	Quantity	8 per Node	8 per Node
		Capacity per DIMM (GB)	8GB	64 GB
		Total Memory Amount (GB)	64 GB	512 GB
	SSD	SSD Quantity	2	2
	PSU	Quantity	1	1
Model		AXX1300TCRPS	AXX1300TCRPS	
FW		BIOS: SE5C6200.86B.0020.P09 BMC: 2.66.dab52082 FRU: FRUSDR_0.31		
Measured and Calculated Server Allowance	P Base		25	25
	Additional CPU		89.8	179.2
	Additional Power Supply		0	0
	Storage Devices		10	10
	Additional Memory		10.8	91.44
	Additional I/O Device (10Gx 15W/2Port on MB)		0	0
	Perfcpu		8.98	17.92
Limits/ Results	Idle power allowances (W)		135.6	305.7
	Idle power tested (W) Per node		<b>109.8</b>	<b>121</b>
	Minimum Eff <sub>ACTIVE</sub>		9	9
	Eff <sub>ACTIVE</sub> tested		<b>26.7</b>	<b>39.7</b>
Other test result	Idle Power at Higher Temp. (per Node) @ 35 degree C		122.3	135.6
	Max Power (W Per Node)		311.8	459.3

## Energy Efficiency Data of M500001UR – 2 (Dual) Processors Installed Configuration

Configuration			2 CPUs Low-end Config.	2 CPUs High-end Config.
Details	Chassis	Model	M500001UR	
	Node/MB	Quantity	1	1
		Model	M50CYP	M50CYP
	CPU	Quantity	2 per Node	2 per Node
		Model	Gold 6346	Platinum 8380
	Memory	Quantity	16 per Node	16 per Node
		Capacity per DIMM (GB)	8 GB	64 GB
		Total Memory Amount (GB)	128 GB	1024 GB
	SSD	SSD Quantity	2	2
	PSU	Quantity	2	2
Model		AXX1300TCRPS	AXX1300TCRPS	
FW		BIOS: SE5C6200.86B.0020.P09 BMC: 2.66.dab52082 FRU: FRUSDR_0.31		
Measured and Calculated Server Allowance	P Base		38	38
	Additional CPU		125.8	246.7
	Additional Power Supply		10	10
	Storage Devices		10	10
	Additional Memory		22.32	183.6
	Additional I/O Device (10Gx 15W/2Port on MB)		0	0
	Perfcpu		17.96	35.24
Limits/ Results	Idle power allowances (W)		206.1	488.3
	Idle power tested (W) Per node		<b>161.1</b>	<b>192.7</b>
	Minimum Eff <sub>ACTIVE</sub>		9.5	9.5
	Eff <sub>ACTIVE</sub> tested		<b>30.3</b>	<b>43.2</b>
Other test result	Idle Power at Higher Temp. (per Node) @ 35 degree C		177.4	207.4
	Max Power (W Per Node)		586.7	869.1

## Other Information:

<b>Chemical Declaration</b>
<ul style="list-style-type: none"> <li>Neodymium Not Applicable. (No HDD offered by Intel)</li> <li>Cobalt Not Applicable. (No BBUs. Coin battery is out of scope)</li> </ul>

## Appendix I. Glossary

Term	Definition
<b>ACPI</b>	Advanced Configuration and Power Interface
<b>ARP</b>	Address Resolution Protocol
<b>ASHRAE</b>	American Society of Heating, Refrigerating and Air-Conditioning Engineers
<b>BBS</b>	BIOS Boot Selection
<b>BMC</b>	Baseboard Management Controller
<b>BIOS</b>	Basic Input/Output System
<b>CFM</b>	Cubic Feet per Minute
<b>CMOS</b>	Complementary Metal-oxide-semiconductor
<b>CPU</b>	Central Processing Unit
<b>DDR4</b>	Double Data Rate 4
<b>DHCP</b>	Dynamic Host Configuration Protocol
<b>DIMM</b>	Dual In-line Memory Module
<b>DPC</b>	DIMMs per Channel
<b>EDS</b>	External Design Specification
<b>EFI</b>	Extensible Firmware Interface
<b>EPS</b>	External Product Specification
<b>EVAC</b>	Enhanced Volume Air Cooling
<b>FP</b>	Front Panel
<b>FRB</b>	Fault Resilient Boot
<b>FRU</b>	Field Replaceable Unit
<b>GPGPU</b>	General Purpose Graphic Processing Unit
<b>GPIO</b>	General Purpose Input/Output
<b>GUI</b>	Graphical User Interface
<b>I<sup>2</sup>C</b>	Inter-integrated Circuit bus
<b>IMC</b>	Integrated Memory Controller
<b>IIO</b>	Integrated Input/Output
<b>iPC</b>	Intel Product Code
<b>IPMI</b>	Intelligent Platform Management Interface
<b>ISTA</b>	International Safe Transit Association
<b>KVM</b>	Keyboard, Video, and Mouse
<b>JRE</b>	Java Runtime Environment
<b>LED</b>	Light Emitting Diode
<b>LFM</b>	Linear Feet per Minute – Airflow measurement
<b>LPC</b>	Low-pin Count
<b>LRDIMM</b>	Load Reduced DIMM
<b>LSB</b>	Least Significant Bit

Term	Definition
<b>MSB</b>	Most Significant Bit
<b>MKTME</b>	Multi-key Total Memory Encryption
<b>MLE</b>	Measured Launched Environment
<b>MM</b>	Memory Mode
<b>MRC</b>	Memory Reference Code
<b>MTBF</b>	Mean Time Between Failure
<b>NAT</b>	Network Address Translation
<b>NIC</b>	Network Interface Controller
<b>NMI</b>	Non-maskable Interrupt
<b>NTB</b>	Non-Transparent Bridge
<b>NVMe*</b>	Non-Volatile Memory Express (NVMe*) is an optimized, high-performance scalable storage interface designed to address the needs of enterprise systems that use PCIe®-based solid-state storage. NVMe* provides efficient access to non-volatile memory storage devices. NVMe* allows host hardware and software to take advantage of the levels of parallelism possible in modern SSDs.
<b>OCuLink</b>	Optical Copper Link
<b>OEM</b>	Original Equipment Manufacturer
<b>OCP*</b>	Open Compute Project
<b>OR</b>	Oct (8) Rank
<b>OTP</b>	Over Temperature Protection
<b>OVP</b>	Over-voltage Protection
<b>PCH</b>	Peripheral Controller Hub
<b>PCI</b>	Peripheral Component Interconnect
<b>PCB</b>	Printed Circuit Board
<b>PCIe*</b>	Peripheral Component Interconnect Express*
<b>PECI</b>	Platform Environment Control Interface
<b>PFC</b>	Power Factor Correction
<b>Intel® PFR</b>	Intel® Platform Firmware Resilience
<b>PHM</b>	Processor Heat sink Module
<b>PMBus</b>	Power Management Bus
<b>PMem</b>	Persistent Memory Module
<b>POST</b>	Power-on Self-Test
<b>PSU</b>	Power Supply Unit
<b>PWM</b>	Pulse Width Modulation
<b>QR</b>	Quad Rank
<b>RAID</b>	Redundant Array of Independent Disks
<b>RAM</b>	Random Access Memory
<b>RAS</b>	Reliability, Availability, and Serviceability
<b>RCiEP</b>	Root Complex Integrated Endpoint
<b>RDIMM</b>	Registered DIMM

<b>Term</b>	<b>Definition</b>
<b>ROC</b>	RAID On Chip
<b>SAS</b>	Serial Attached SCSI
<b>SFUP</b>	System Firmware Update Package
<b>SATA</b>	Serial Advanced Technology Attachment
<b>SEL</b>	System Event Log
<b>SCA</b>	Single Connector Attachment
<b>SCSI</b>	Small Computer System Interface
<b>SDR</b>	Sensor Data Record
<b>SFF</b>	Small Form Factor
<b>SFP</b>	Small Form-factor Pluggable
<b>SMBus</b>	System Management Bus
<b>SMTP</b>	Simple Mail Transfer Protocol
<b>SNMP</b>	Simple Network Management Protocol
<b>SOL</b>	Serial-over-LAN
<b>SR</b>	Single Rank
<b>SSD</b>	Solid State Device
<b>SSH</b>	Secure Shell
<b>TCG</b>	Trusted Computing Group
<b>TDP</b>	Thermal Design Power
<b>TPM</b>	Trusted Platform Module
<b>TPS</b>	Technical Product Specification
<b>Intel® TXT</b>	Intel® Trusted Execution Technology
<b>UEFI</b>	Unified Extensible Firmware Interface
<b>VLSI</b>	Very Large Scale Integration
<b>VR</b>	Voltage Regulator
<b>VSB</b>	Voltage Standby
<b>Intel® VROC</b>	Intel® Virtual RAID on CPU